

STUCK AUS

MEISTERHAND

Kompetenz seit über 50 Jahren



STUCKGESCHÄFT

SEIT 1948

STUCKWERKSTATT · BERATUNG · AUSSTELLUNG · VERKAUF
RESTAURATOR FÜR INNEN- UND AUSSENSTUCK · STEINRESTAURIERUNG

INHALTSVERZEICHNIS

Rosetten	1
Knöpfe · Beschläge	8
Profile	10
Eckverzierungen	20
Supraporten	26
Säulen · Pilaster	29
Kapitelle · Konsolen	32
Lichtverteiler	36
Dekorelemente	38
Kamine · Konschen	44
Baluster	47

Belz GmbH · Bornheimer Straße 33a · 53111 Bonn
Telefon (02 28) 60 40 7-0 · Fax (02 28) 60 40 777
eMail: stuck@belz.de · www.belz.de

Alle Maßangaben in diesem Katalog sind als annähernd zu betrachten.
Geringfügige, produktionsbedingte Differenzen sind daher möglich.

In unserem Online-Katalog haben Sie außerdem die Möglichkeit, die
abgebildeten Produkte als Fotoansicht anzusehen.

Die Preise unserer Artikel entnehmen Sie bitte der jeweils gültigen Preisliste.
Es gelten unsere allgemeinen Liefer- und Zahlungsbedingungen.

Rosetten



Rosetten bilden den krönenden Mittelpunkt einer Stuckdecke. Ganz gleich, welche Größe, Ausführung oder Stilrichtung Sie benötigen, wir helfen Ihnen gerne bei der Auswahl. Die Verarbeitung von reinem Alabastergips bei der Fertigung der Rosetten bürgt für dauerhafte Qualität, an der Sie lange Freude haben werden.

In unserer Ausstellung haben Sie die Möglichkeit, alle abgebildeten und weitere Rosetten im eingebauten Zustand zu sehen.

ROSETTEN

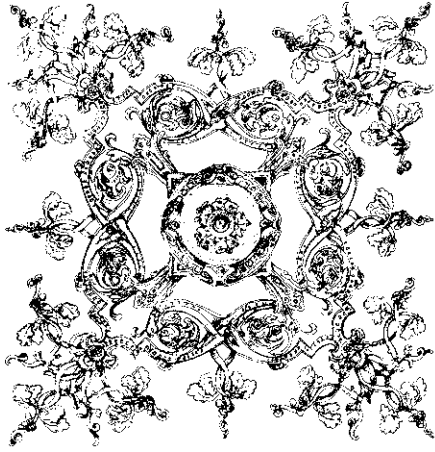

Ø 200 cm · D 17 cm

ROS 1001

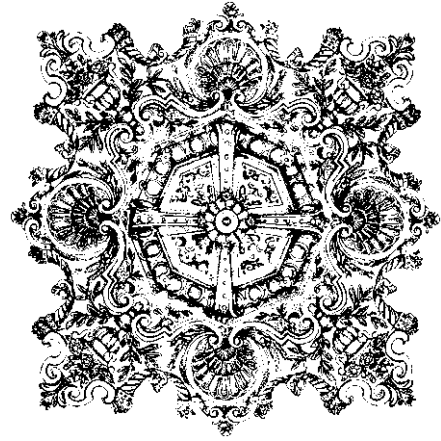

Ø 210 cm · Innenteil Ø 87 cm · D 23 cm

ROS 1014

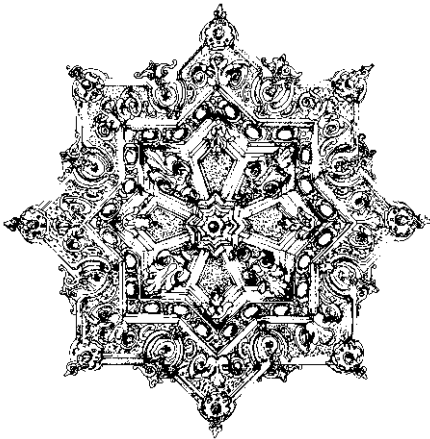

Ø 134 cm · D 12 cm

ROS 1062

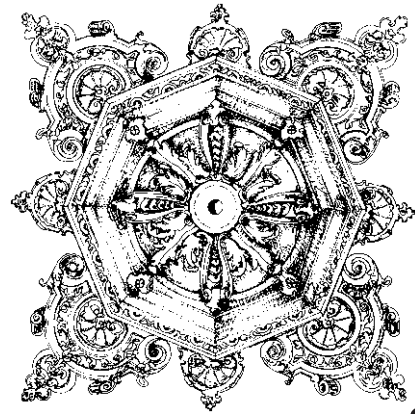

Ø 154 cm (ROS 1012A)

Innenteil (ROS 1012) Ø 82 cm · D 11 cm

ROS 1012 A

ROS 1012

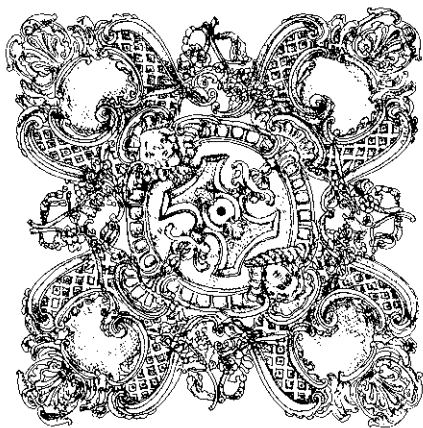

Ø 145 cm · D 10 cm

ROS 1007

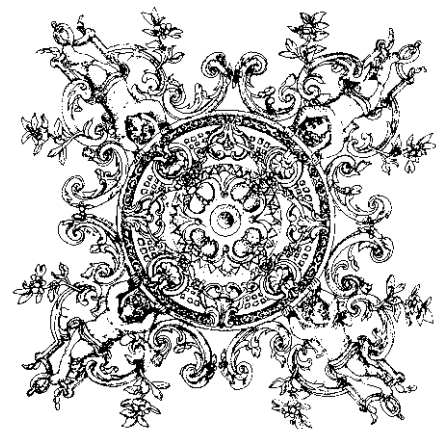

Ø 140 cm · D 11 cm

ROS 1061 A

ROSETTEN

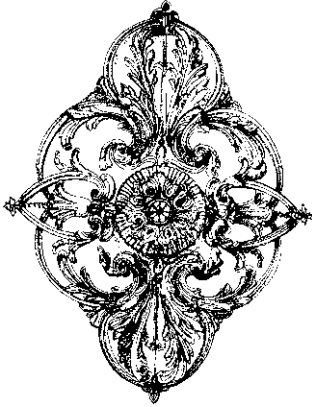

L 94 cm · B 72 cm · D 4 cm

ROS 52

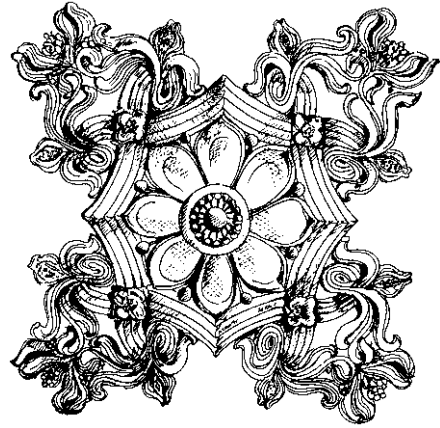

Ø 81 cm · D 5 cm

ROS 1067

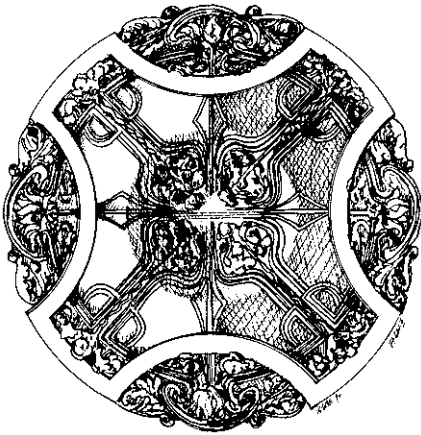

Ø 87 cm · D 6 cm

ROS 1066

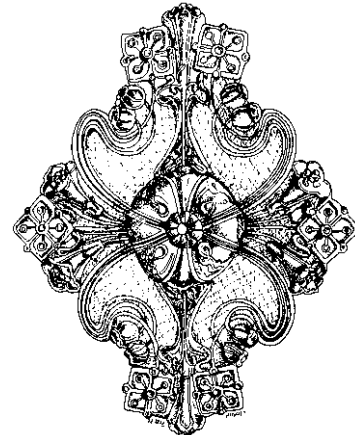

L 90 cm · 72 cm · D 7,5 cm

ROS 1065

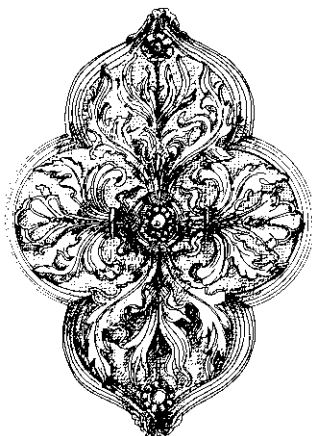

L 100 cm · B 71 cm · D 9 cm

ROS 1060

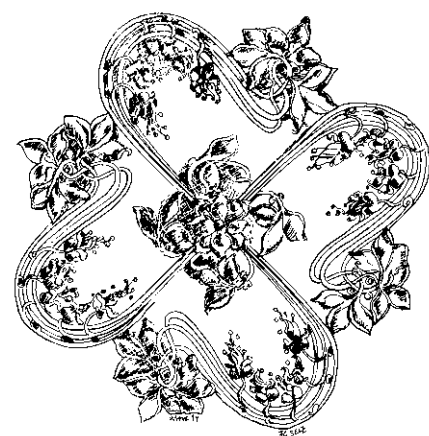

Ø 95 cm · D 10 cm

ROS 1064

ROSETTEN

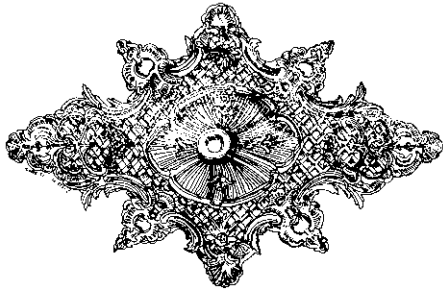

L 142 cm · B 90 cm · D 10 cm

ROS 1006

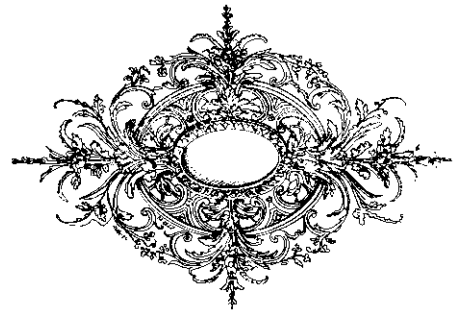

L 143 cm · B 100 cm · D 3 cm

ROS 908

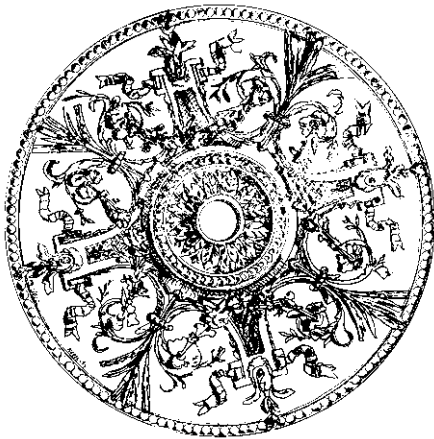

Ø 84 cm · D 4,5 cm

ROS 906

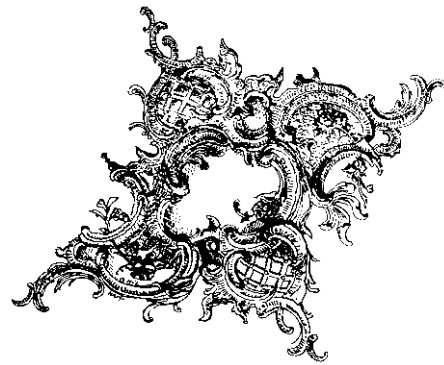

L 150 cm · B 120 cm · D 6 cm

ROS 1015



L 95 cm · B 81 cm · D 5 cm

ROS 901

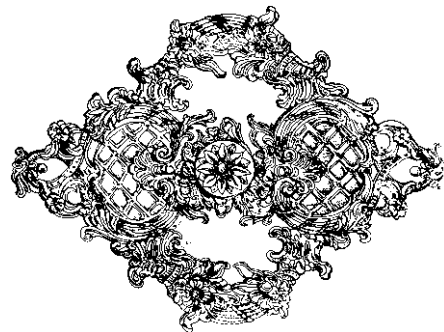

L 94 cm · B 66 cm · D 4,5 cm

ROS 121 L

ROSETTEN

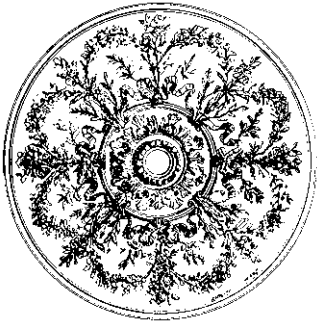

Ø 95 cm · D 6,5 cm

ROS 904

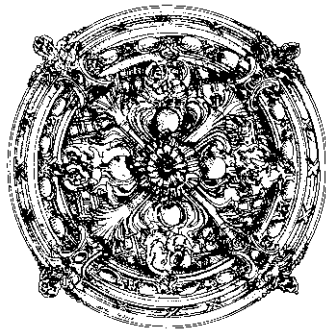

Ø 101 cm · D 15 cm

ROS 1076

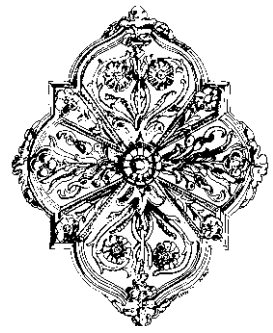

L 99 cm · B 82 cm
D 11 cm

ROS 1052



L 106 cm · B 60 cm
D 16 cm

ROS 1050

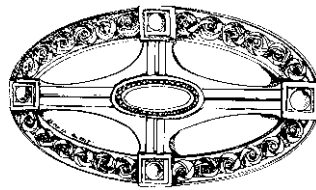

L 93 cm · B 54 cm
D 2,5 cm

ROS 1051

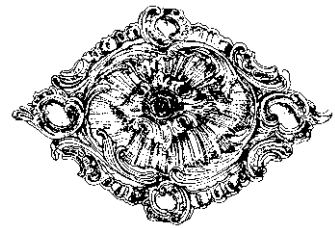

L 69 cm · B 48 cm
D 5,5 cm

ROS 323

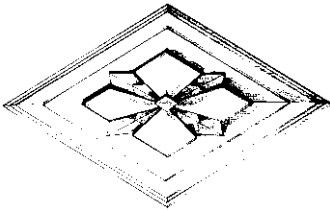

L 65 cm · B 40 cm
D 1,5 cm

ROS 99

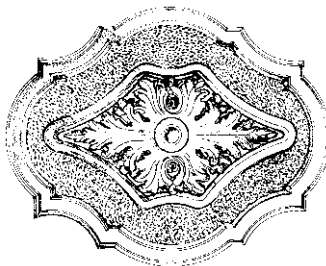

L 59 cm · B 46,5 cm
D 2 cm

ROS 46

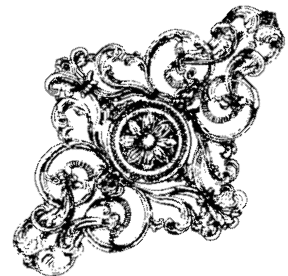

L 63 cm · B 44 cm
D 1,5 cm

ROS 56



Ø 62 cm · D 5,5 cm

ROS 1071

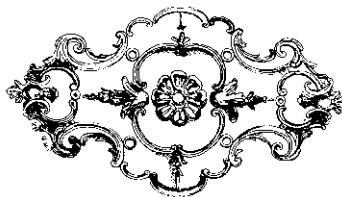

L 71 cm · B 41 cm
D 2 cm

ROS 51

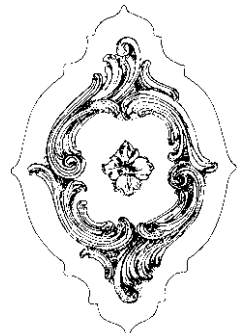

L 61 cm · B 42 cm
D 1,5 cm

ROS 127

ROSETTEN

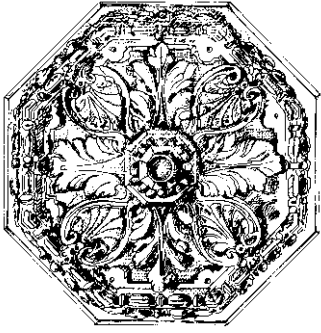

Ø 66 cm · D 14 cm

ROS 1059

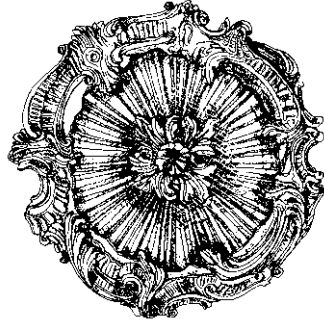

Ø 45 cm · D 3,5 cm

ROS 307

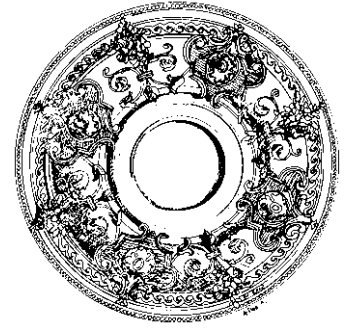

Ø 76 cm · D 5 cm

ROS 905

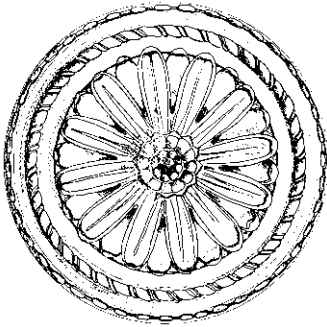

Ø 41 cm · D 5 cm

ROS 29

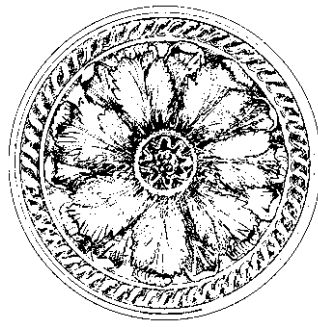

Ø 53 cm · D 6 cm

ROS 113

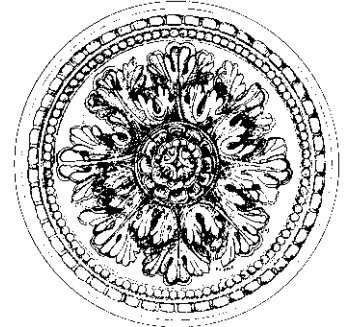

Ø 35 cm · D 2 cm

ROS 402

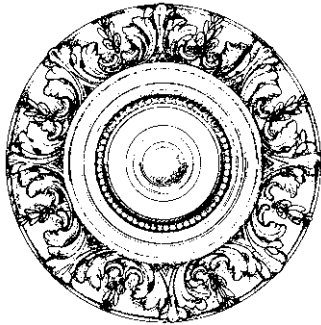

Ø 51 cm · D 3 cm

ROS 112

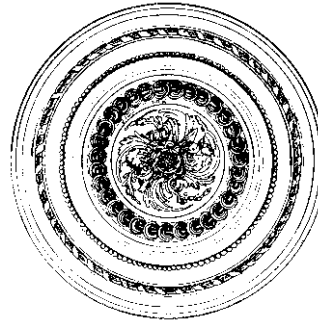

Ø 65 cm · D 4,5 cm

ROS 242

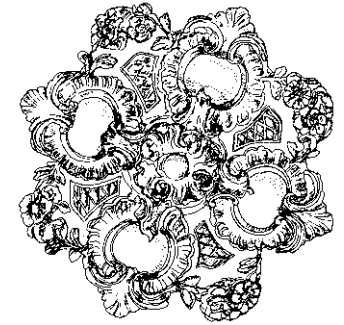

Ø 47 cm · D 3,5 cm

ROS 116

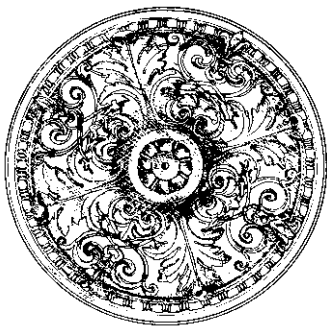

Ø 55 cm · D 5,5 cm

ROS 22

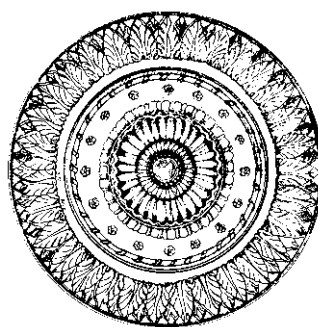

Ø 67 cm · D 6,5 cm

ROS 243

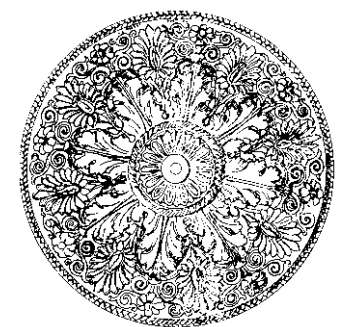

Ø 67 cm · D 3 cm

ROS 444

ROSETTEN

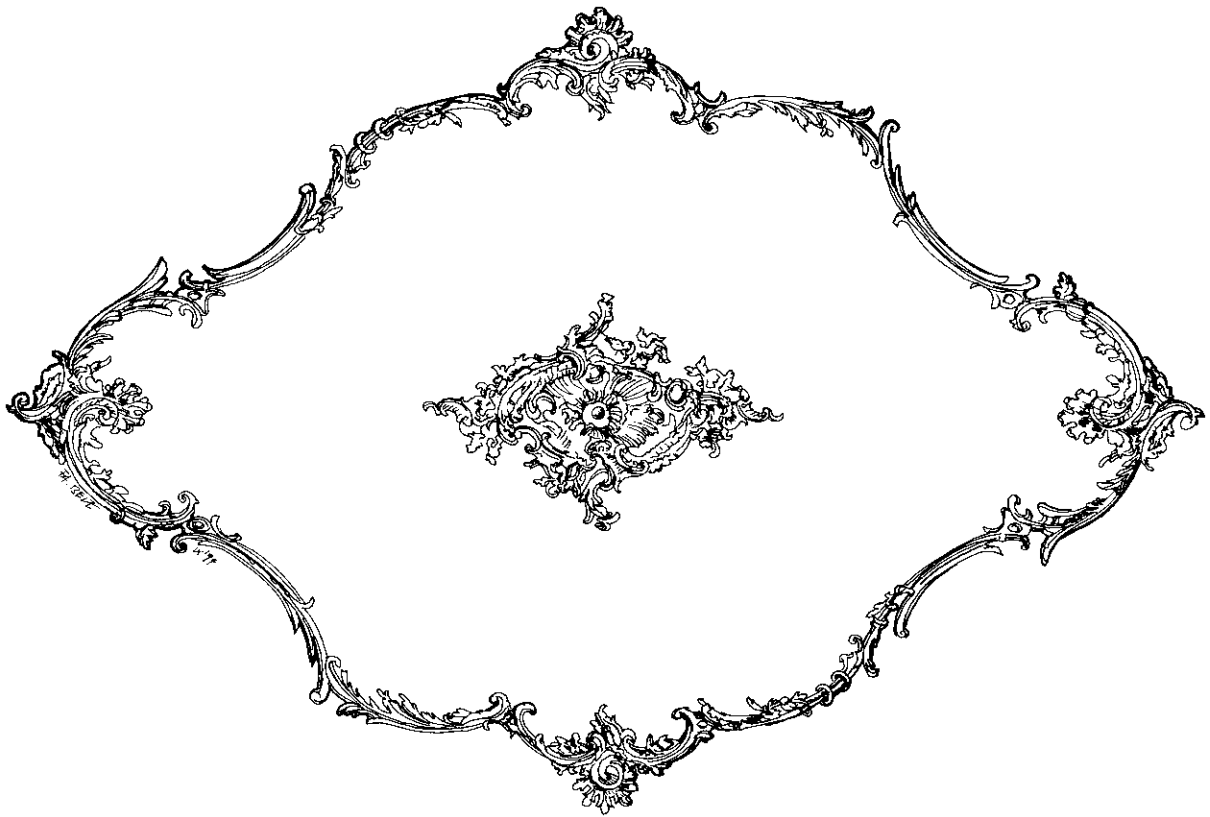

Außenteil (ROS 1601) L 290 cm · B 190 cm · Innenteil (ROS 606) L 88 cm · B 56 cm

ROS 1601 · 606

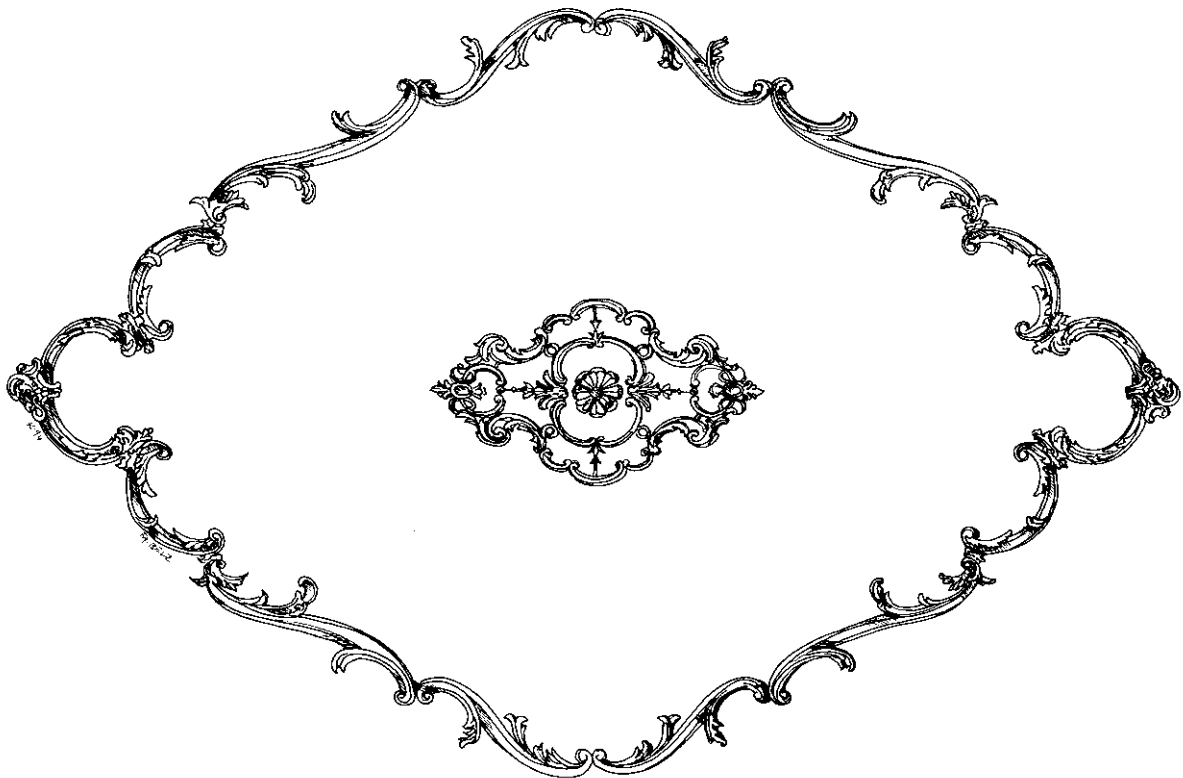

Außenteil (ROS 1600) L 260 cm · B 160 cm · Innenteil (ROS 51) L 71 cm · B 41 cm

ROS 1600 · 51

Knöpfe • Beschläge

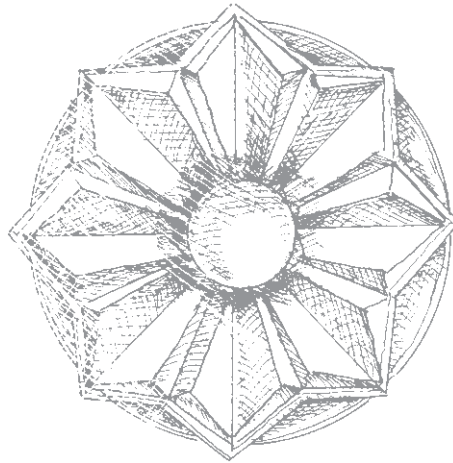
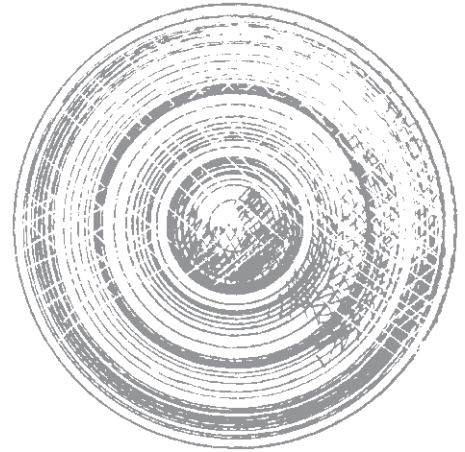
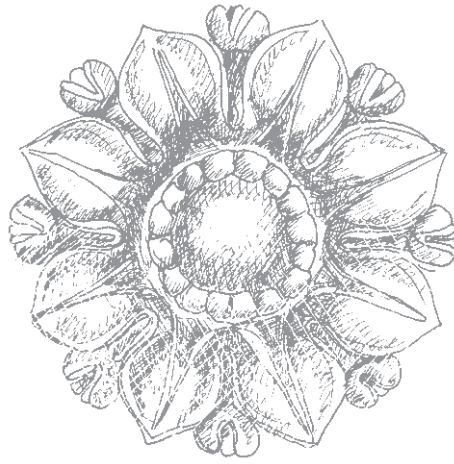

Unter Knöpfen und Beschlägen verstehen wir dekorative Einzelemente. Die Verwendungsmöglichkeiten sind vielfältig und nicht nur auf die Zierelemente an Stuckdecken begrenzt. Lassen Sie Ihrer Phantasie doch einfach freien Lauf.

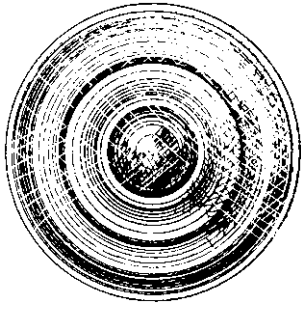

Ø 15,5 cm

KB 355

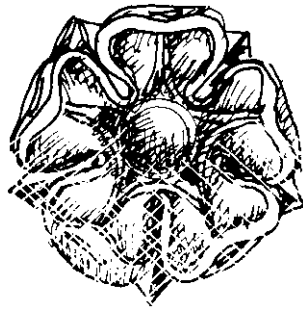

Ø 9 cm

KB 351

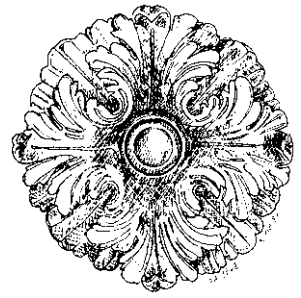

Ø 22 cm

KB 440

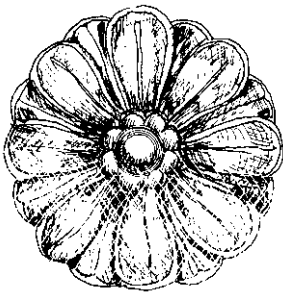

Ø 15 cm

KB 71

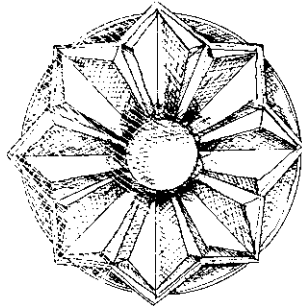

Ø 11,5 cm

KB 143

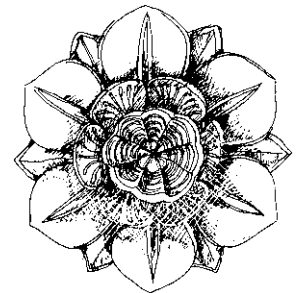

Ø 19 cm

KB 53

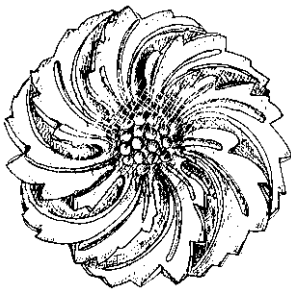

Ø 12 cm

KB 76

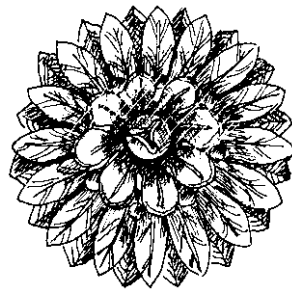

Ø 15 cm

KB 441

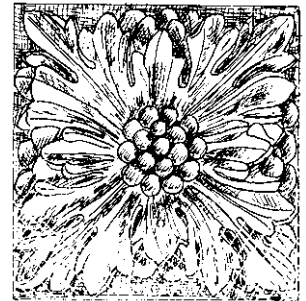

B 11 cm · H 11 cm

KB 104

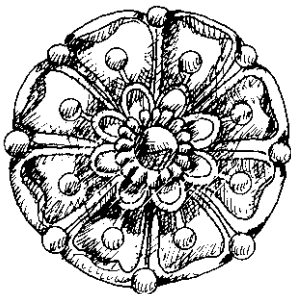

Ø 13 cm

KB 141

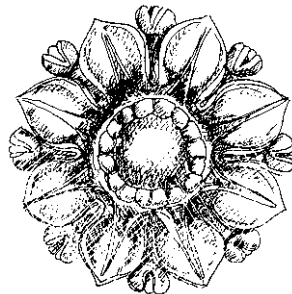

Ø 19 cm

KB 50

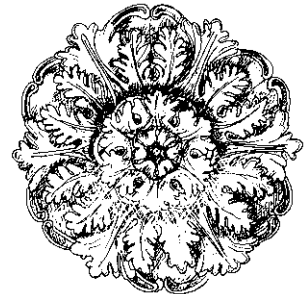

Ø 19,5 cm

KB 237



Profile

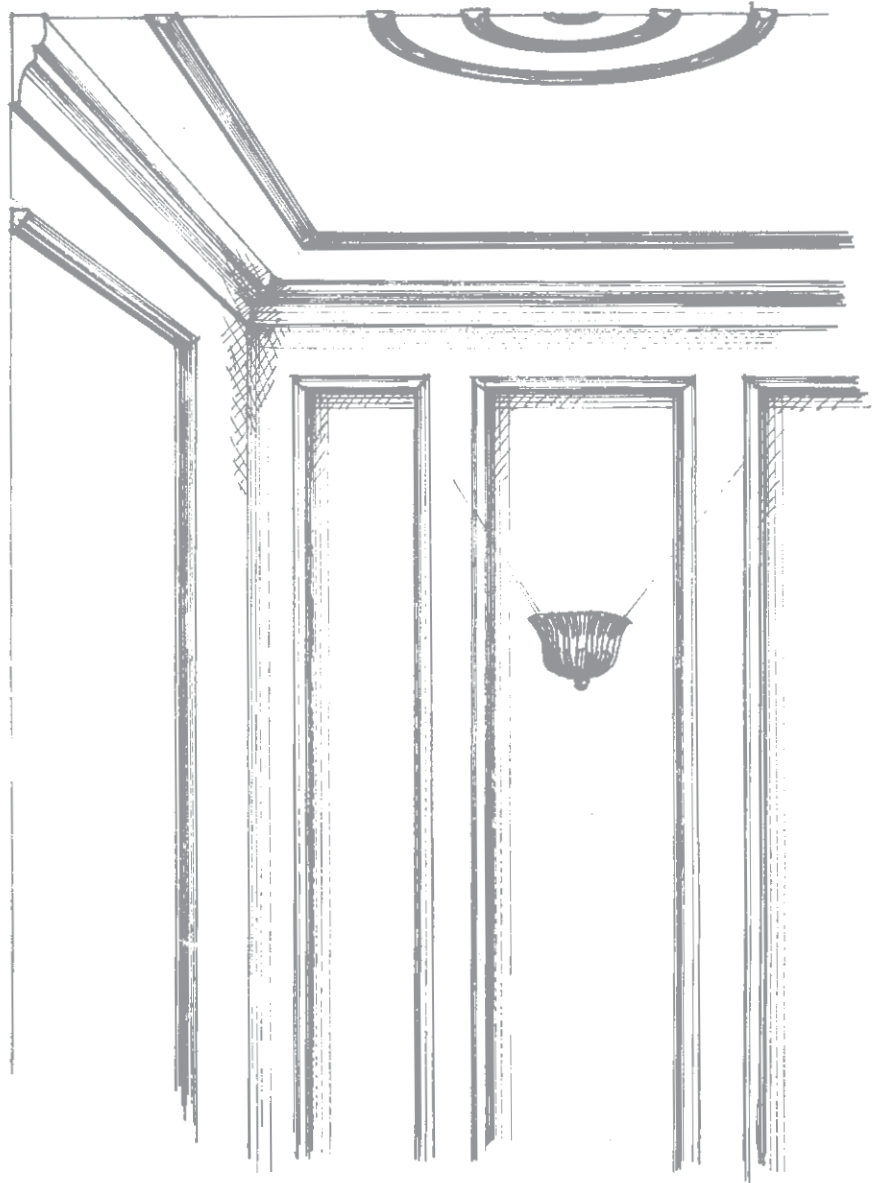

Profile unterscheiden sich nach ihren Anwendungsgebieten wie Eckgesimse, Decken- und Wandprofile.

So bilden Eckgesimse eine harmonische Verbindung zwischen Wand- und Deckenflächen. Stuckleisten ermöglichen individuelle Gestaltungen – ganz nach Ihren kreativen Vorstellungen.

Eine umfangreiche Übersicht aller Originalprofile finden Sie in unseren Ausstellungsräumen in Bonn. Dort werden Sie auch fachmännisch über viele Kombinationsmöglichkeiten von Stuckelementen beraten.

PROFILE

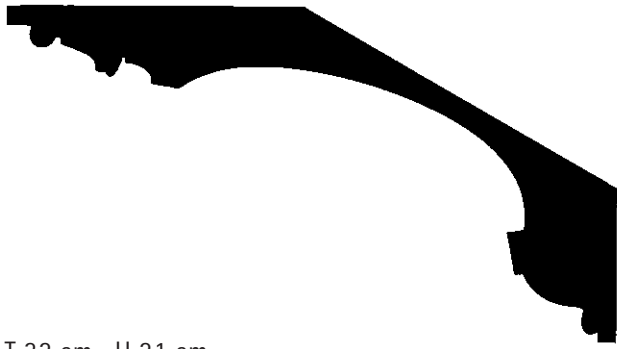

L 150 cm · T 32 cm · H 21 cm

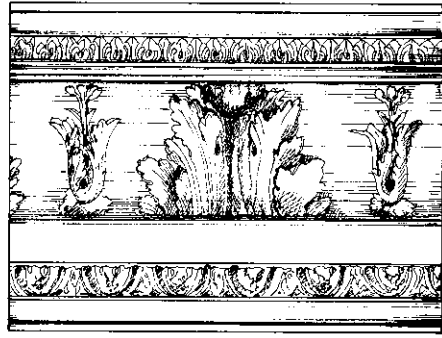

PRO 729

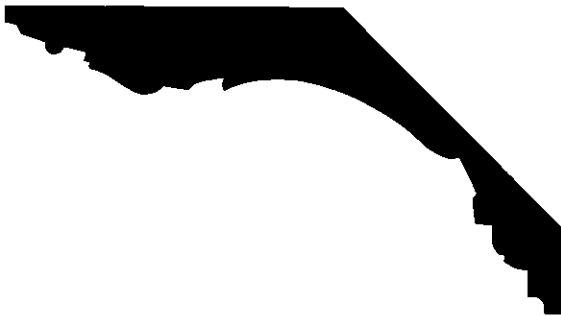

L 150 cm · T 28 cm · H 17 cm

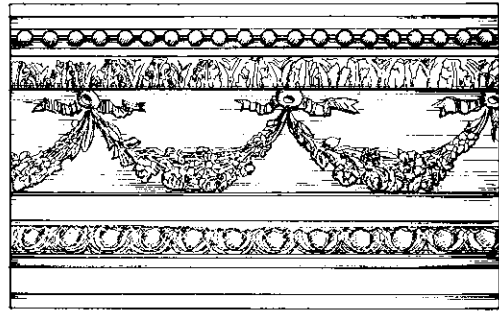

PRO 731

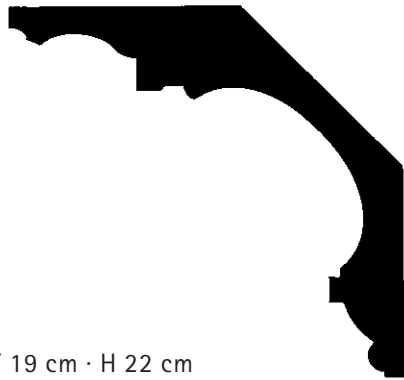

L 58 cm · T 19 cm · H 22 cm

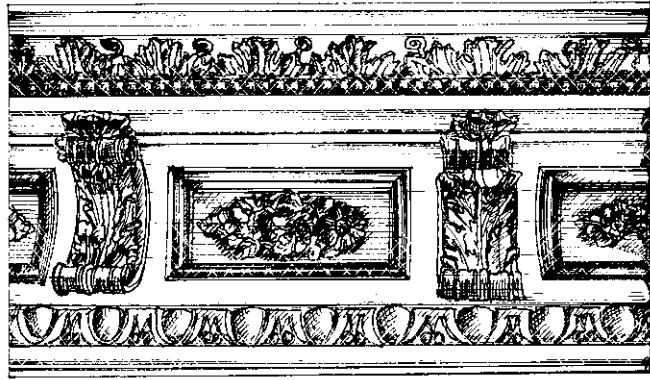

PRO 103

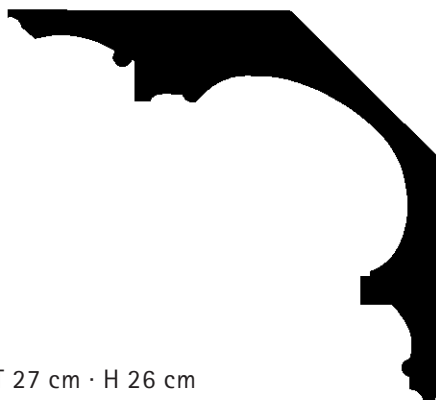

L 88 cm · T 27 cm · H 26 cm

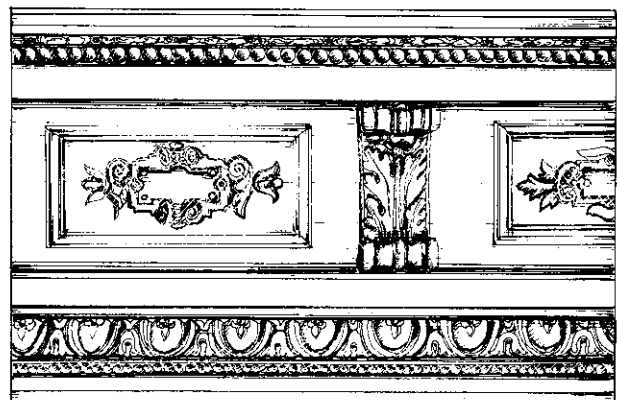

PRO 102

PROFILE

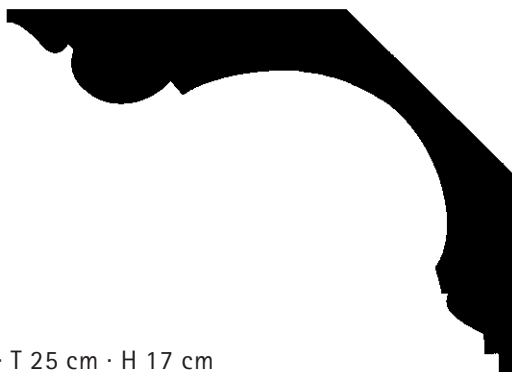

L 150 cm · T 25 cm · H 17 cm

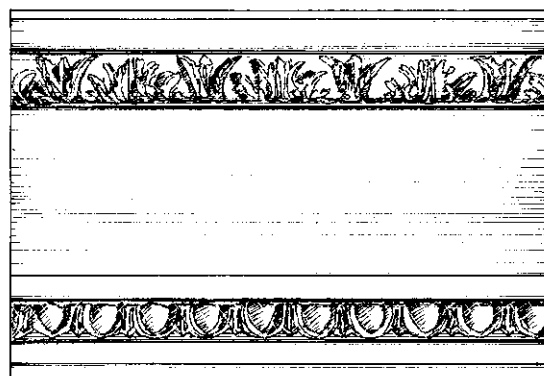

PRO 105



L 150 cm · T 20 cm · H 14 cm

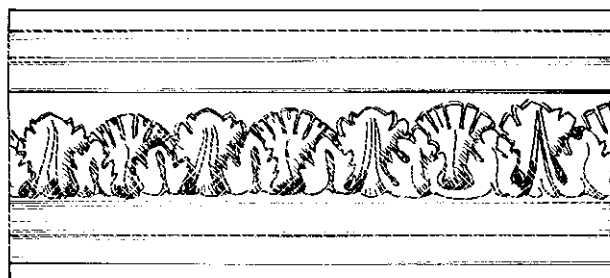

PRO 713

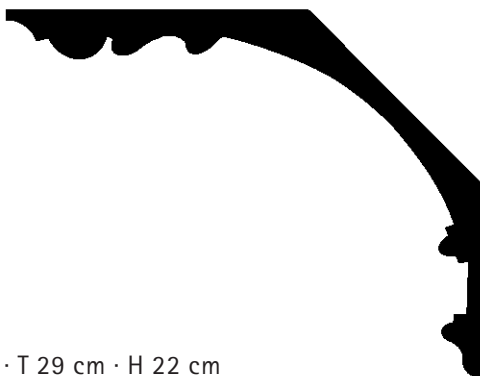

L 150 cm · T 29 cm · H 22 cm

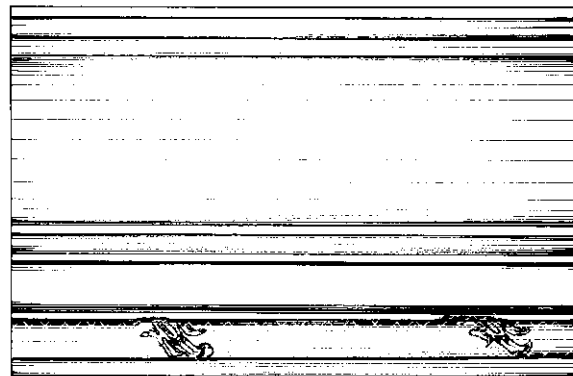

PRO 104



L 150 cm · T 22 cm · H 15 cm

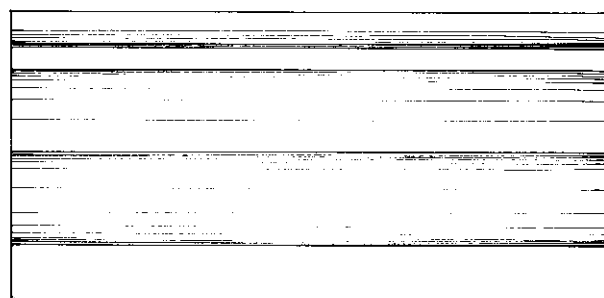

PRO 751



PROFILE

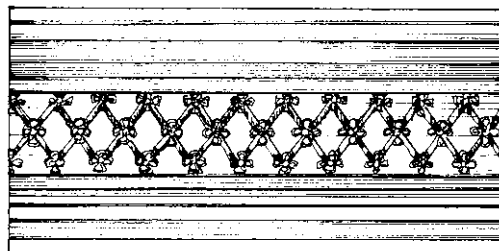
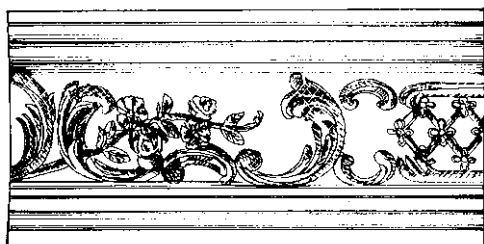

PRO 710

PRO 714

L 150 cm · T 9 cm · H 17 cm

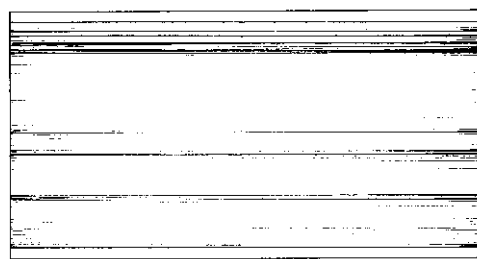
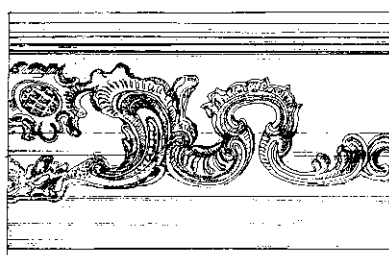

PRO 8 S

PRO 9 S

L 160 cm · T 18 cm · H 20 cm

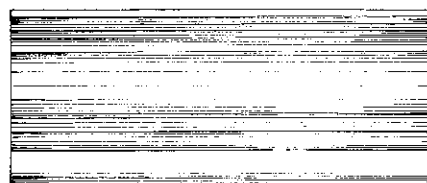
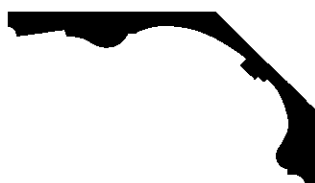
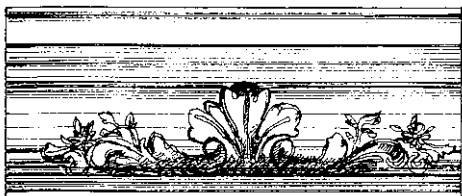

PRO 765

PRO 764

L 150 cm · T 19 cm · H 14 cm



L 150 cm · T 13 cm · H 13 cm

PRO 712

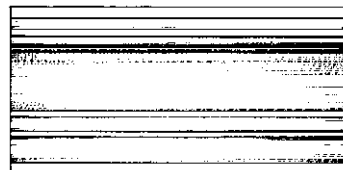

L 150 cm · T 17 cm · H 12 cm

PRO 733

PROFILE

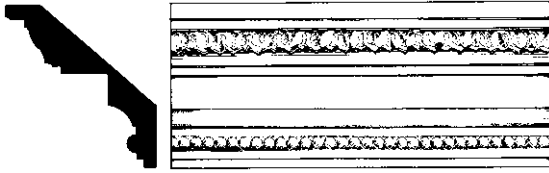

L 150 cm · T 11 cm · H 14 cm

PRO 297

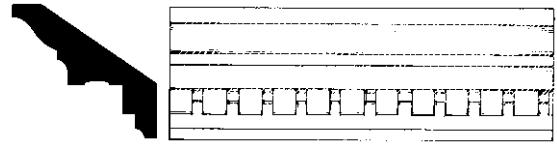

L 150 cm · T 9 cm · H 10 cm

PRO 711

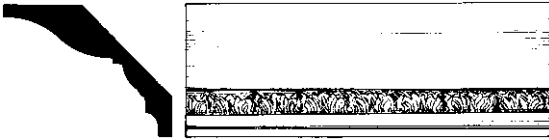

L 150 cm · T 10 cm · H 10 cm

PRO 718

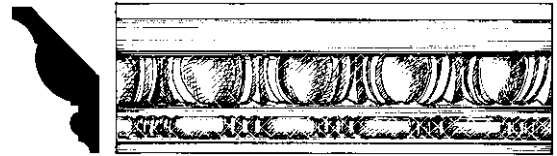

L 150 cm · T 6 cm · H 10 cm

PRO 766



L 150 cm · T 4 cm · H 7,5 cm

PRO 726

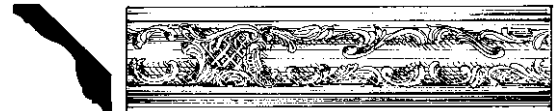

L 150 cm · T 9,5 cm · H 9,5 cm

PRO 715 S

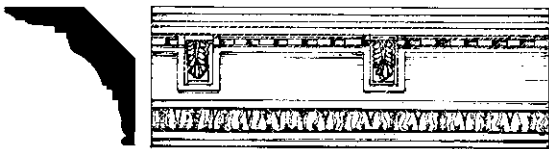

L 150 cm · T 10 cm · H 10 cm

PRO 294

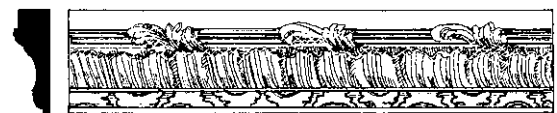

L 150 cm · T 3,5 cm · H 8,5 cm

PRO 708



L 150 cm · T 4,5 cm · H 14 cm

PRO 281



L 150 cm · T 6,5 cm · H 6,5 cm

PRO 722



L 150 cm · T 4 cm · H 9,5 cm

PRO 709



L 150 cm · T 3,5 cm · H 7,5 cm

PRO 282

PROFILE

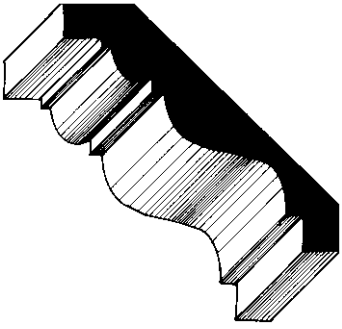

L 150 cm
T 7 cm · H 8 cm

PRO 769

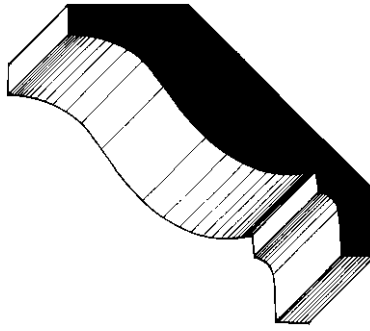

L 150 cm
T 10 cm · H 8 cm

PRO 762

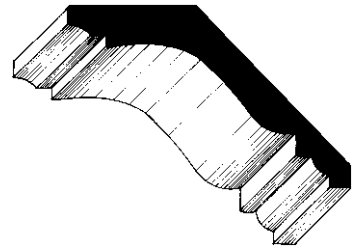

L 150 cm
T 10 cm · H 8,5 cm

PRO 745

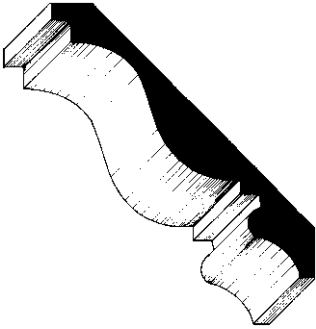

L 150 cm
T 13 cm · H 13 cm

PRO 760

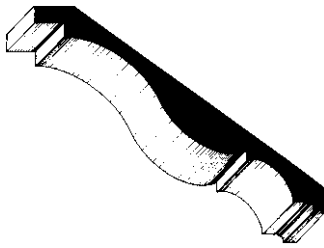

L 150 cm
T 14,5 cm · H 12,5 cm

PRO 716

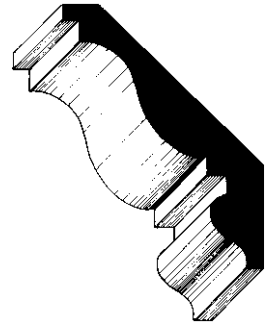

L 150 cm
T 9 cm · H 10,5 cm

PRO 755

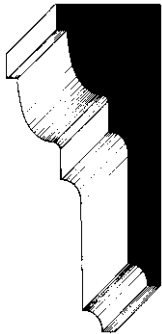

L 150 cm
T 4,5 cm · H 12 cm

PRO 723

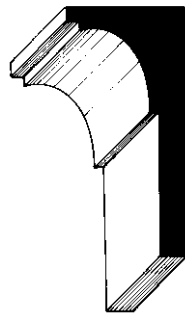

L 150 cm
T 4 cm · H 9 cm

PRO 724

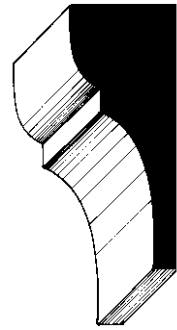

L 150 cm
T 3,5 cm · H 9 cm

PRO 768

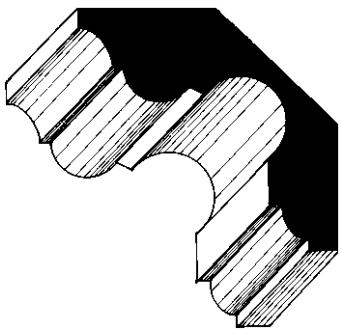

L 150 cm
T 7,5 cm · H 7 cm

PRO 298

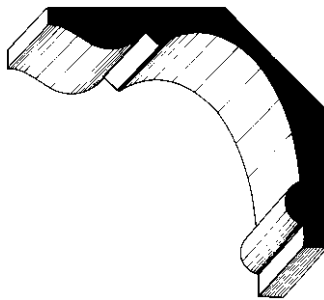

L 150 cm
T 10,5 cm · H 10,5 cm

PRO 744

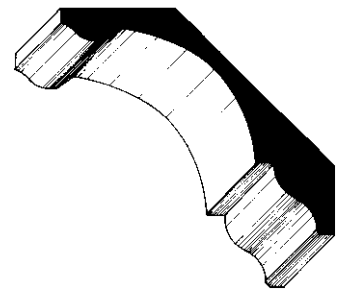

L 150 cm
T 10 cm · H 9,5 cm

PRO 719



PROFILE



L 150 cm · D 1,7 cm · B 6,5 cm

PRO 290



L 152 cm · D 2,3 cm · B 4,8 cm

PRO 706



L 145 cm · D 1,7 cm · B 4 cm

PRO 704



L 150 cm · D 2 cm · B 4,8 cm

PRO 63 B



L 150 cm · D 2 cm · B 5,8 cm

PRO 265



L 150 cm · D 1,6 cm · B 4 cm

PRO 292



L 150 cm · D 1,2 cm · B 4 cm

PRO 27 B



L 150 cm · D 1,4 cm · B 4,2 cm

PRO 66 B



L 150 cm · D 1,5 cm · B 4 cm

PRO 24 B



L 150 cm · D 2 cm · B 5,3 cm

PRO 715



L 150 cm · D 1,5 cm · B 4 cm

PRO 48 A



L 150 cm · D 1 cm · B 3,5 cm

PRO 255

PROFILE

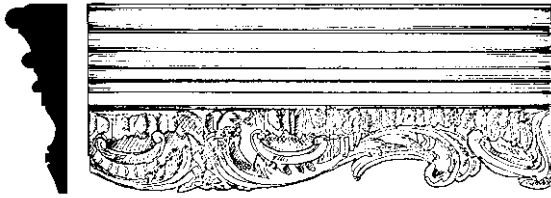

L 160 cm · D 4 cm · B 13,5 cm

PRO 703



L 150 cm · D 1,5 cm · B 8,5 cm

PRO 280



L 150 cm · D 1,5 cm · B 7,5 cm

PRO 727

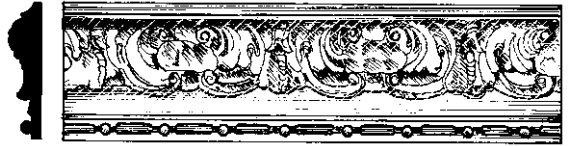

L 150 cm · D 2,5 cm · B 10 cm

PRO 275



L 155 cm · D 2,5 cm · B 7 cm

PRO 310 D

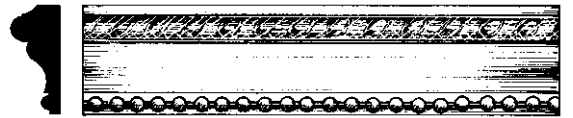

L 150 cm · D 3,4 cm · B 7 cm

PRO 53 B

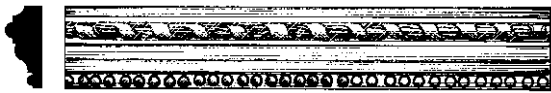

L 150 cm · D 2,5 cm · B 5,6 cm

PRO 278



L 150 cm · D 3,2 cm · B 5,5 cm

PRO 49 A



L 150 cm · D 2,5 cm · B 5,5 cm

PRO 49 C



L 150 cm · D 1 cm · B 5 cm

PRO 701



L 150 cm · D 3,5 cm · B 7,5 cm

PRO 705



L 150 cm · D 2 cm · B 4,4 cm

PRO 707

PROFILE

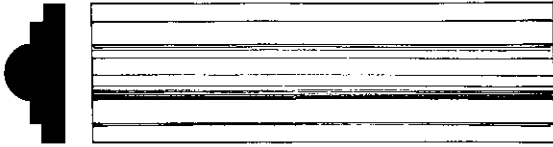

L 150 cm · D 1,2 cm · B 3 cm

PRO 288

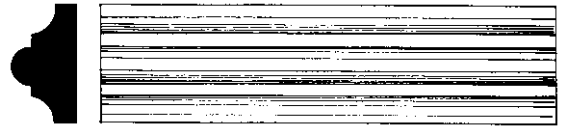

L 150 cm · D 1,5 cm · B 2,5 cm

PRO 720

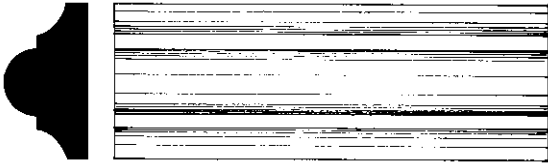

L 150 cm · D 2 cm · B 3,5 cm

PRO 721

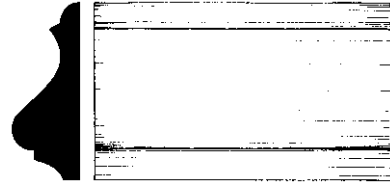

L 150 cm · D 2,5 cm · B 6 cm

PRO 21 C

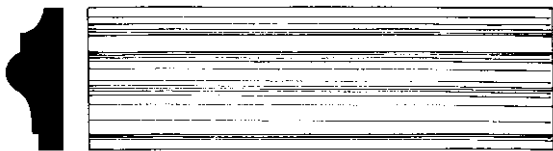

L 150 cm · D 1 cm · B 3 cm

PRO 20 D

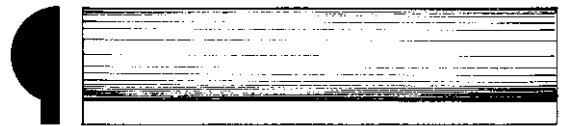

L 150 cm · D 1 cm · B 2,5 cm

PRO 41 B

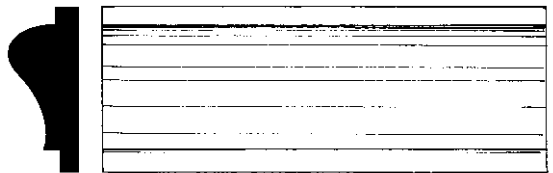

L 150 cm · D 1,5 cm · B 3,7 cm

PRO 68 B

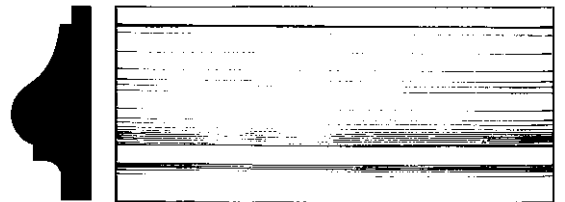

L 150 cm · D 1,7 cm · B 4,5 cm

PRO 50 B

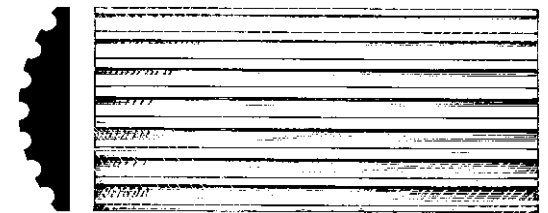

L 150 cm · D 2,5 cm · B 12 cm

PRO 5

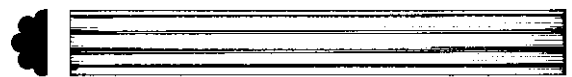

L 150 cm · D 1,7 cm · B 3 cm

PRO 49 B

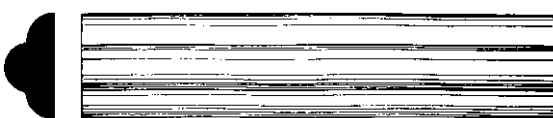

L 150 cm · D 1 cm · B 2,2 cm

PRO 62 B

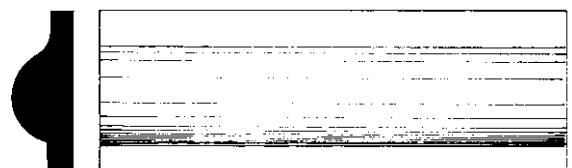

L 150 cm · D 1,5 cm · B 3,3 cm

PRO 23 C

PROFILE

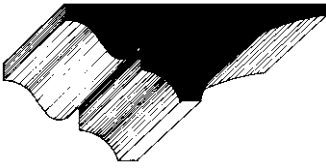

B 9 cm · D 3,5 cm

PRO 122

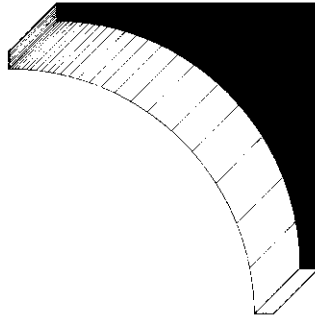

T 12 cm · H 12 cm

PRO 123



H 11,5 cm · D 4 cm

PRO 124

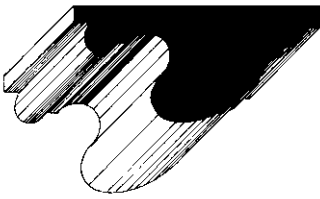

B 7,5 cm · D 4 cm

PRO 125

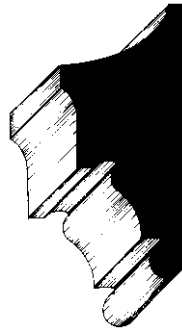

H 11,5 cm · D 5 cm

PRO 126

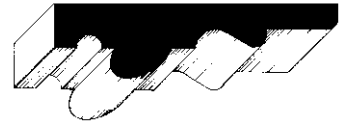

B 13,5 cm · D 4 cm

PRO 127

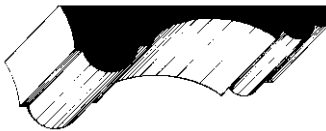

B 11 cm · D 2,5 cm

PRO 128

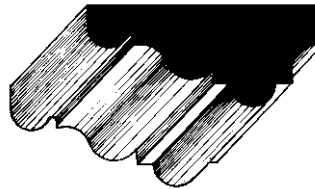

B 19,5 cm · D 5 cm

PRO 129

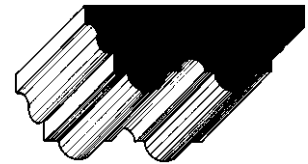

B 6,5 cm · H 2,5 cm

PRO 130

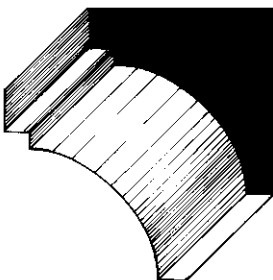

B 4 cm · H 4,3 cm

PRO 283

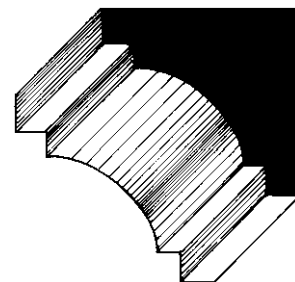

B 3,2 cm · H 3,2 cm

PRO 289

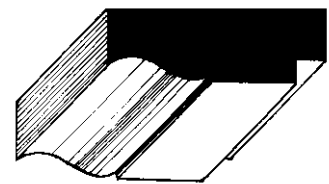

B 3 cm · D 1,2 cm

PRO 753



Eckverzierungen



Unsere handwerklich meisterhaft gefertigten Eckverzierungen werden hauptsächlich als zusätzliche Dekorelemente an Wand- und Deckenfeldern eingesetzt.

Die meisten Eckverzierungen sind mit Profilanschluß versehen.

Dies vereinfacht die vielfältigen Kombinationsmöglichkeiten mit unseren Profilen. Daß die Paßgenauigkeit und damit ein nahtloser Übergang zum Stuckprofil gewährleistet ist, versteht sich von selbst.

Zu PRO 24 B

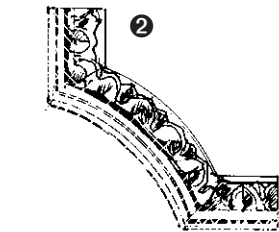
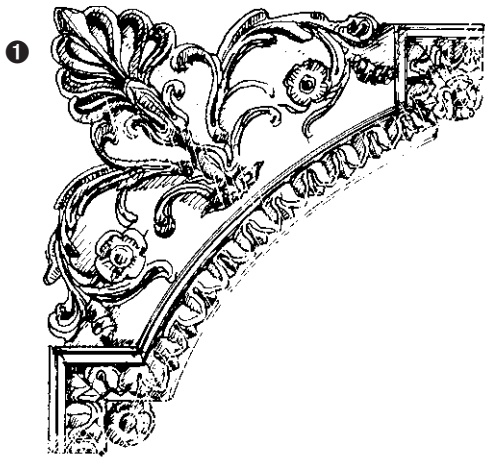

- ❶ (ECK 88) 30 cm x 30 cm
- ❷ (ECK 230) 16 cm x 16 cm

ECK 88

ECK 230

Zu PRO 255

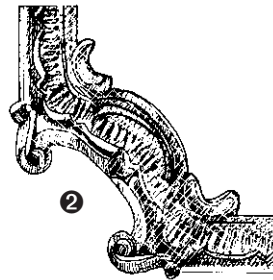
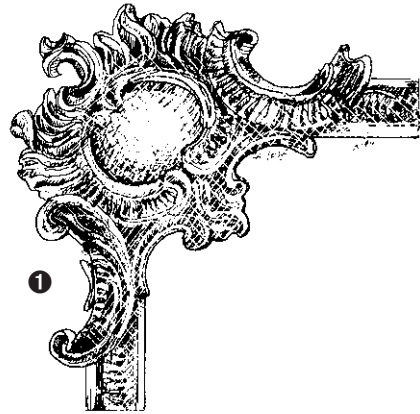

- ❶ (ECK 135) 25 cm x 25 cm
- ❷ (ECK 257) 15 cm x 15 cm

ECK 135

ECK 257

Zu PRO 292

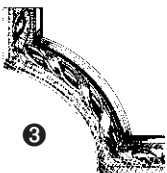
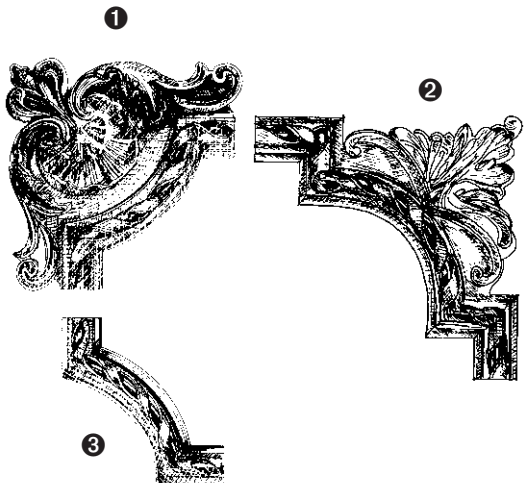

- ❶ (ECK 411) 24 cm x 24 cm
- ❷ (ECK 410) 16 cm x 16 cm
- ❸ (ECK 3 A) 23 cm x 23 cm

ECK 411

ECK 410

ECK 3 A

Zu PRO 66 B

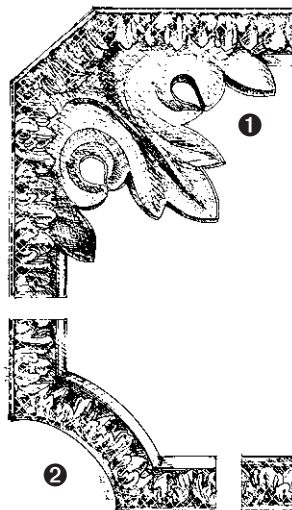

❶

❷

❸

- ❶ (ECK 147) 22 cm x 22 cm
- ❷ (ECK 268) 16 cm x 16 cm
- ❸ (ECK 427) 22 cm x 22 cm

ECK 147

ECK 268

ECK 427

Zu PRO 27 B

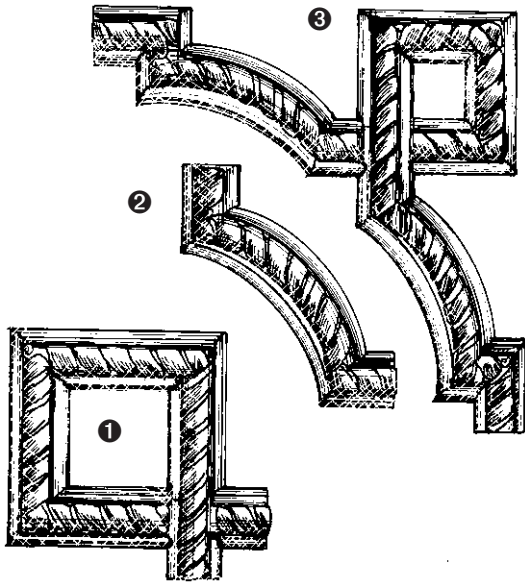

- ❶ (ECK 98) 19 cm x 19 cm
- ❷ (ECK 232) 17 cm x 17 cm
- ❸ (ECK 99) 31 cm x 31 cm

ECK 98

ECK 232

ECK 99

Zu PRO 700

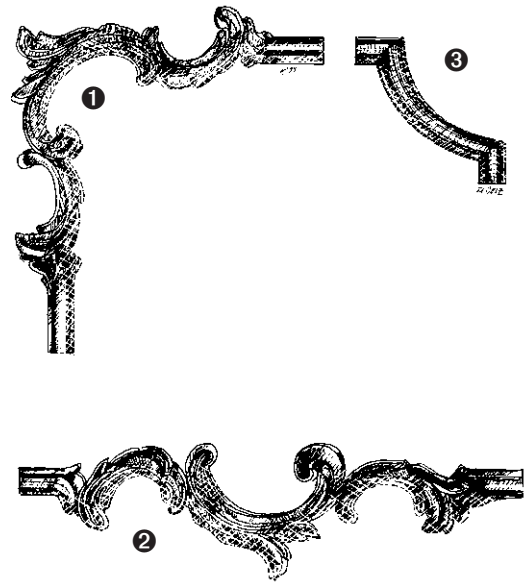

- ❶ (ECK 424) 26 cm x 26 cm
- ❷ (ECK 425) 10 cm x 38 cm
- ❸ (ECK 443) 11 cm x 11 cm

ECK 424

ECK 425

ECK 443

Zu PRO 720

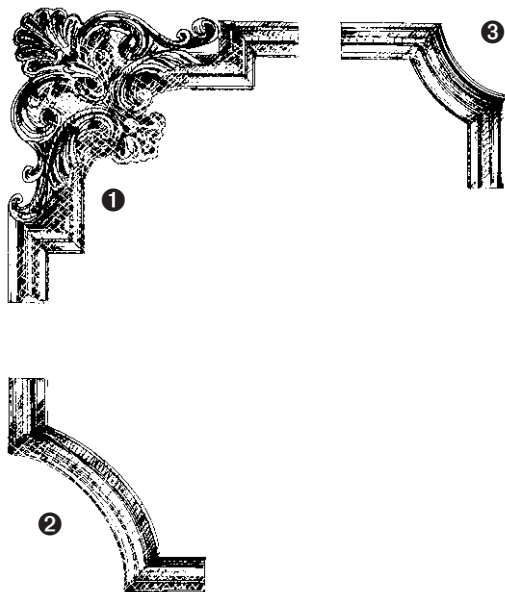

- ❶ (ECK 828) 21 cm x 21 cm
- ❷ (ECK 819) 16 cm x 16 cm
- ❸ (ECK 819 A) 12 cm x 12 cm

ECK 828

ECK 819

ECK 819 A

Zu PRO 68 B

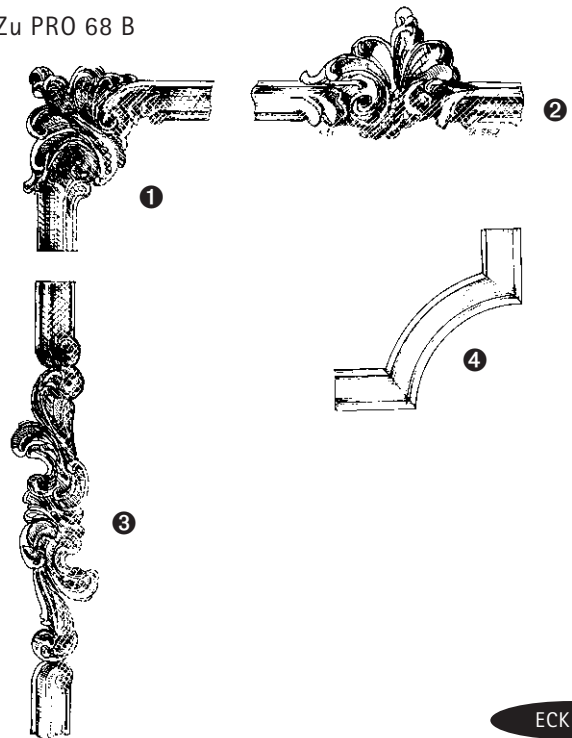

- ❶ (ECK 259) 18 cm x 18 cm
- ❷ (ECK 802) 13 cm x 26 cm
- ❸ (ECK 226) 8 cm x 41,5 cm
- ❹ (ECK 267) 17 cm x 17 cm

ECK 259

ECK 802

ECK 226

ECK 267

ECKVERZIERUNGEN

Zu PRO 50 B

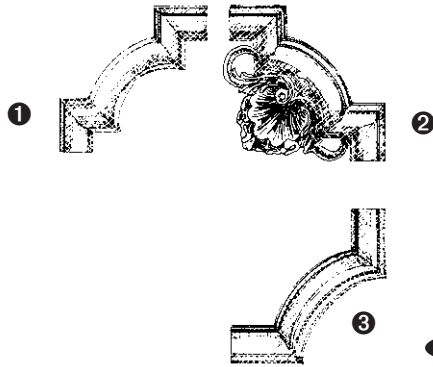

- ❶ (ECK 223) 20 cm x 20 cm
- ❷ (ECK 77) 21 cm x 21 cm
- ❸ (ECK 816) 20 cm x 20 cm

ECK 223

ECK 77

ECK 816

Zu PRO 20 D

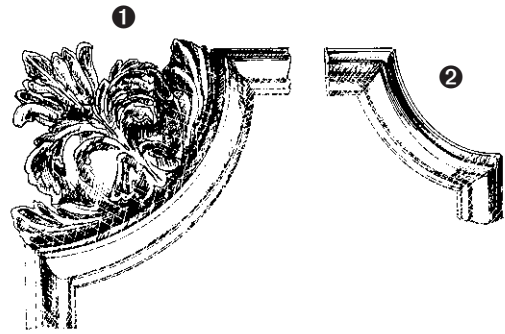

- ❶ (ECK 822) 18 cm x 18 cm
- ❷ (ECK 269) 11,5 cm x 11,5 cm

ECK 822

ECK 269

Zu PRO 48 A

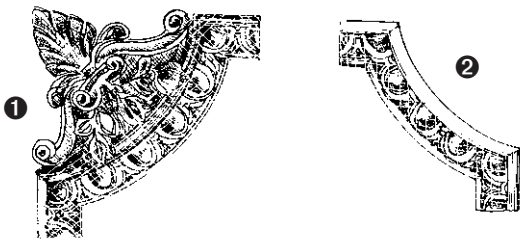

- ❶ (ECK 84) 22 cm x 22 cm
- ❷ (ECK 231) 17 cm x 17 cm

ECK 84

ECK 231

Zu PRO 41 B

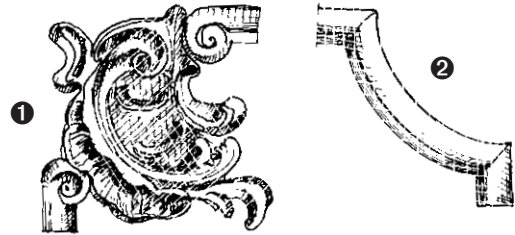

- ❶ (ECK 85) 15 cm x 15 cm
- ❷ (ECK 96) 14 cm x 14 cm

ECK 85

ECK 96

Zu PRO 732

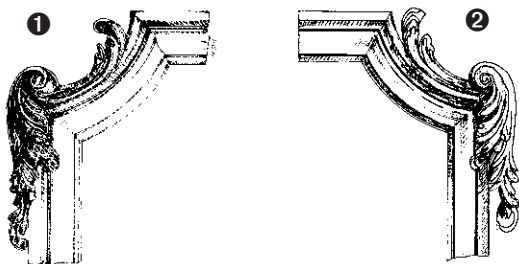

- ❶ (ECK 834) 28 cm x 23 cm
- ❷ (ECK 835) 28 cm x 23 cm

ECK 834

ECK 835

Zu PRO 290

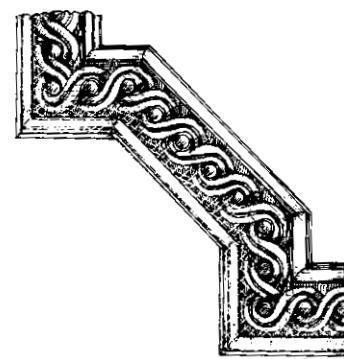

24 cm x 24 cm

ECK 418

ECKVERZIERUNGEN

Zu PRO 715

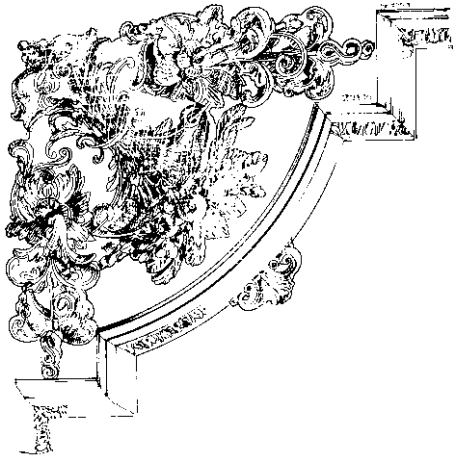

62 cm x 62 cm

ECK 102 L

Zu PRO 727

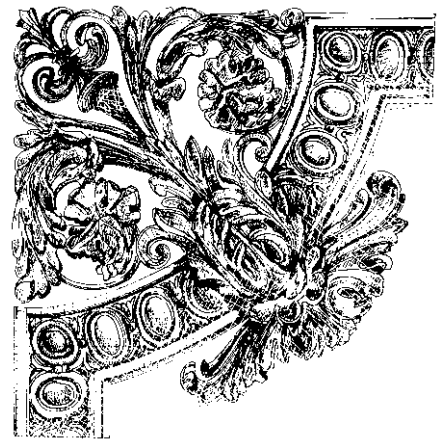

35 cm x 35 cm

ECK 833

Zu PRO 706

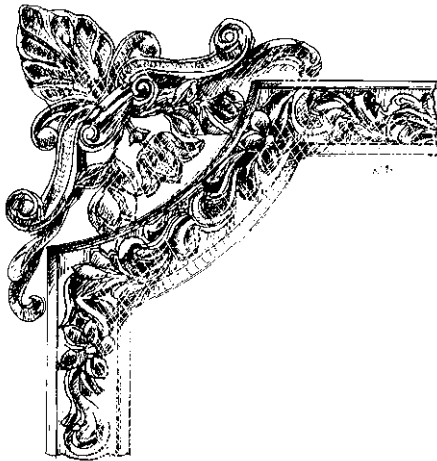

27 cm x 27 cm

ECK 441

Zu PRO 265

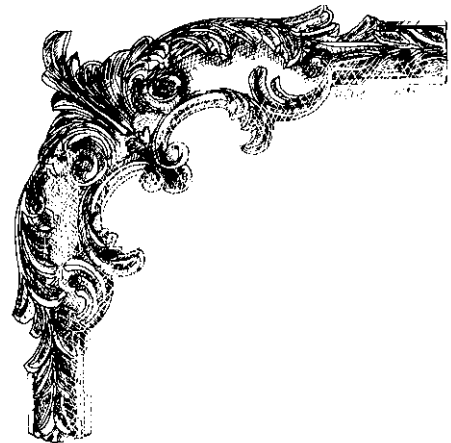

37 cm x 37 cm

ECK 434

Zu PRO 62 B

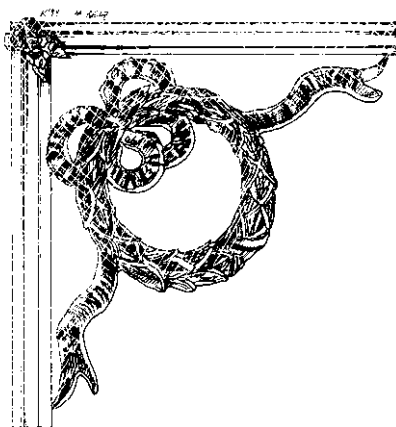

25 cm x 25 cm

ECK 403

Zu PRO 707

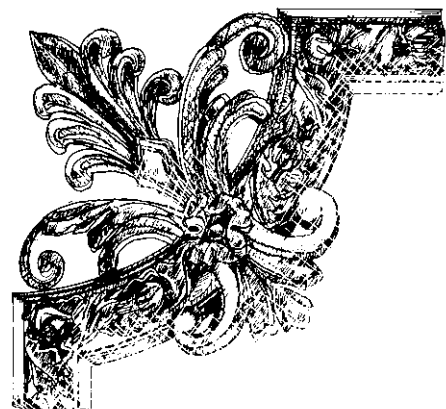

21 cm x 21 cm

ECK 442

ECKVERZIERUNGEN

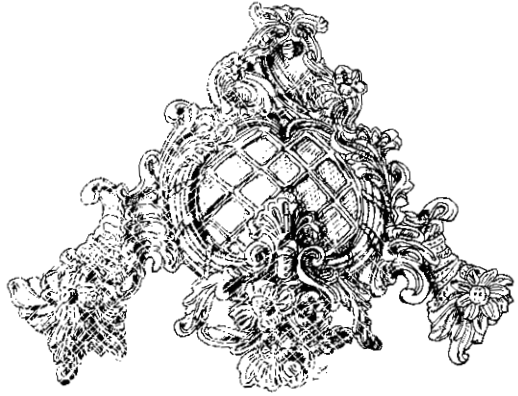

64 cm x 64 cm

ECK 101 L



24 cm x 24 cm

ECK 228

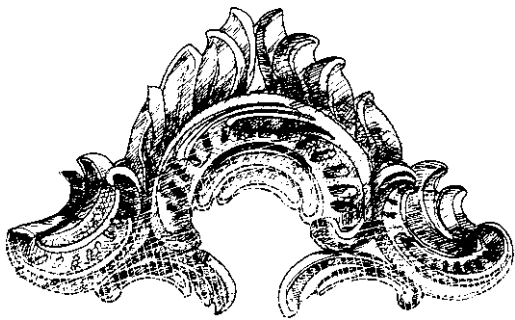

23 cm x 23 cm

ECK 426

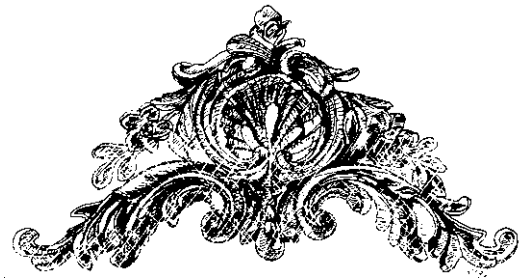

23 cm x 23 cm

ECK 75

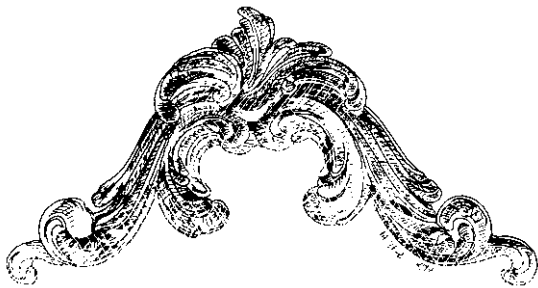

24 cm x 24 cm

ECK 224

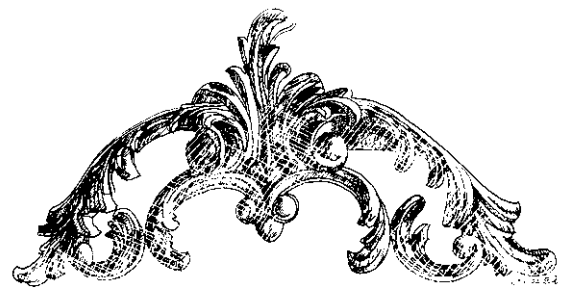

32 cm x 32 cm

ECK 144

Supraporten

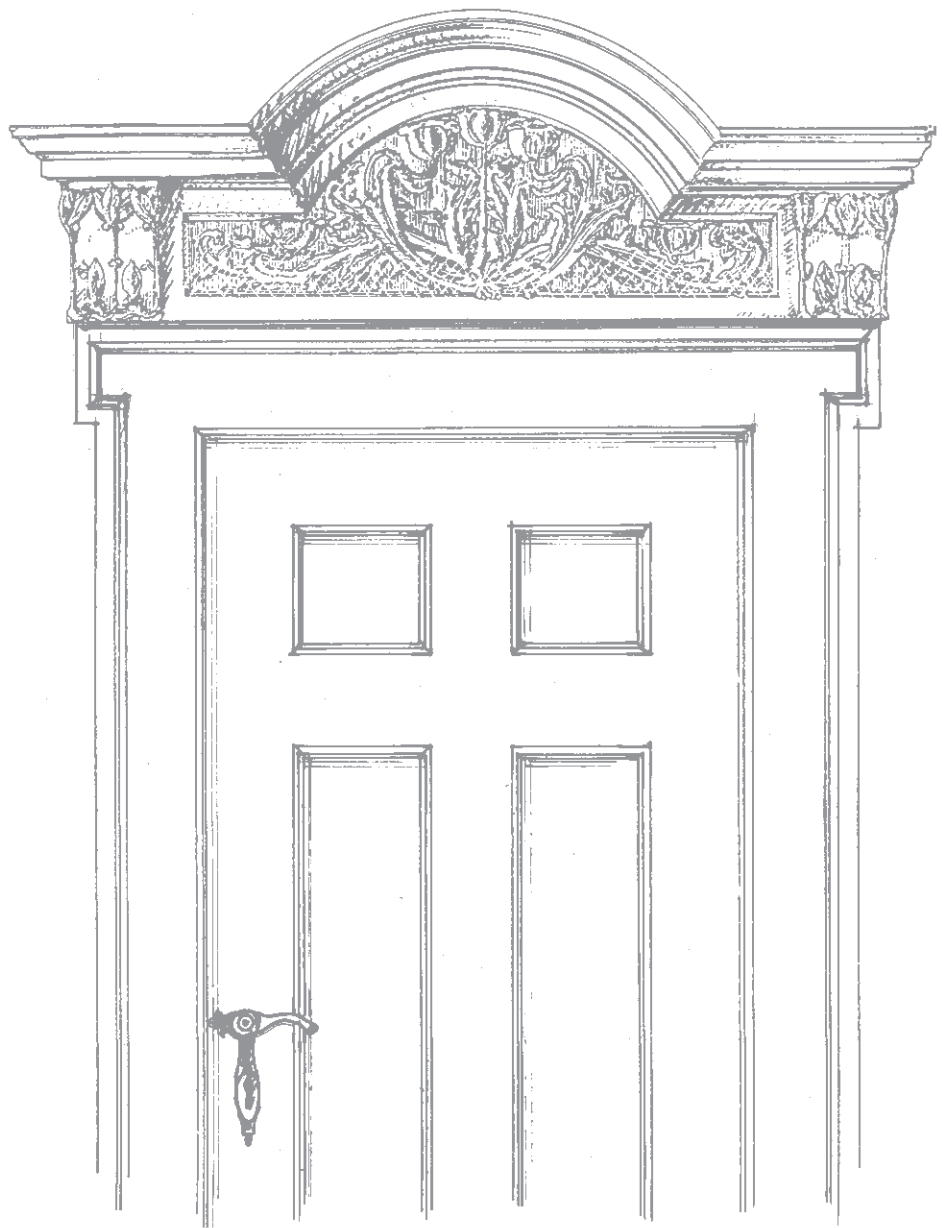

Als Supraporten bezeichnet der Fachmann dekorative Türbekrönungen. Nach überlieferten Originalvorlagen aus feinstem Alabastergips oder Zementmörtel gefertigt, sind diese Stuckelemente sowohl für den Innen- als auch für den Außenbereich individuell einsetzbar.

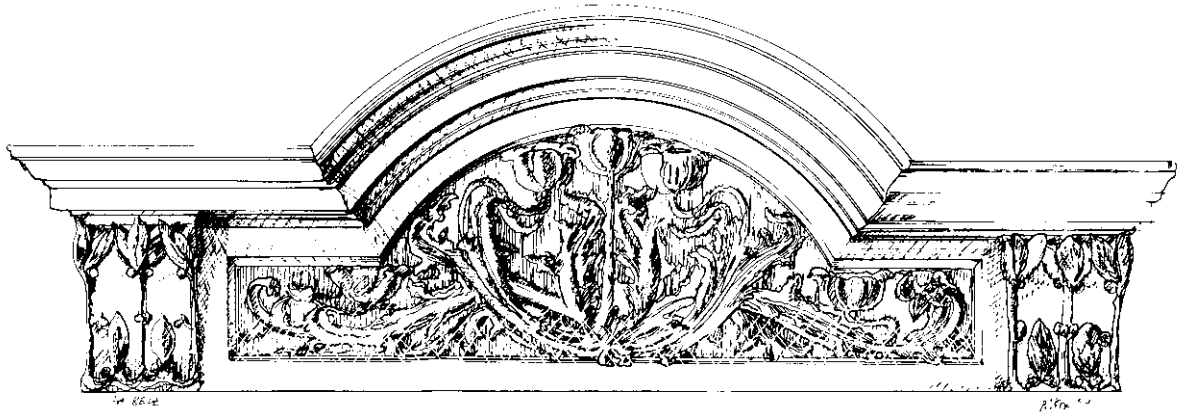

B 127 cm · H 41 cm · T 11 cm

SUP 2090

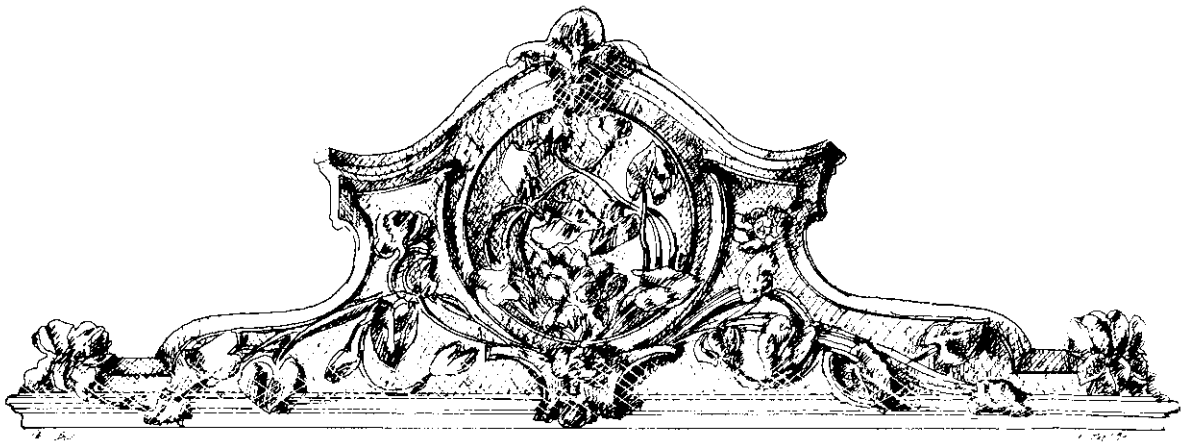

B 127 cm · H 43 cm · T 6 cm

SUP 2091

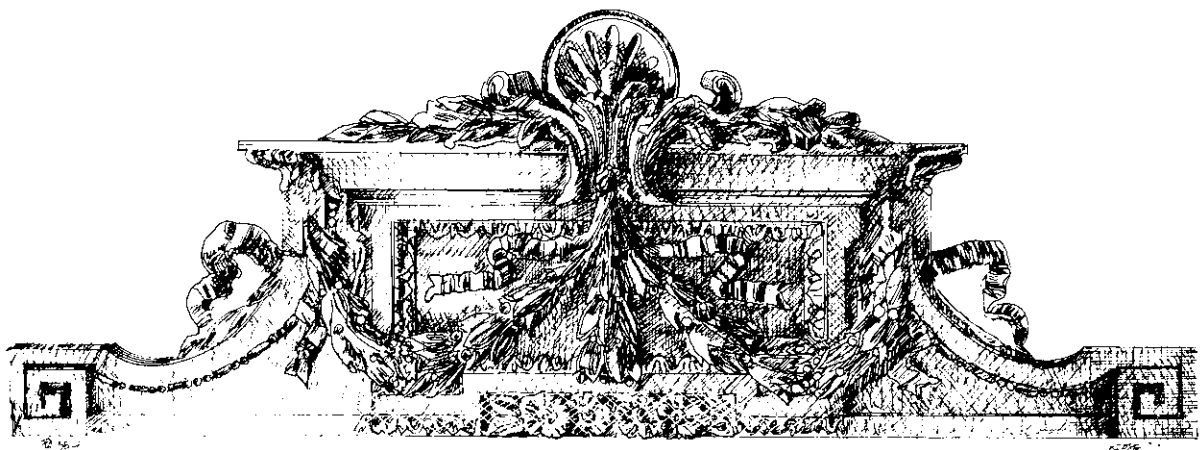

B 120 cm · H 43 cm · T 10 cm

SUP 552



B 124 cm · H 53 cm · T 15 cm

SUP 2092

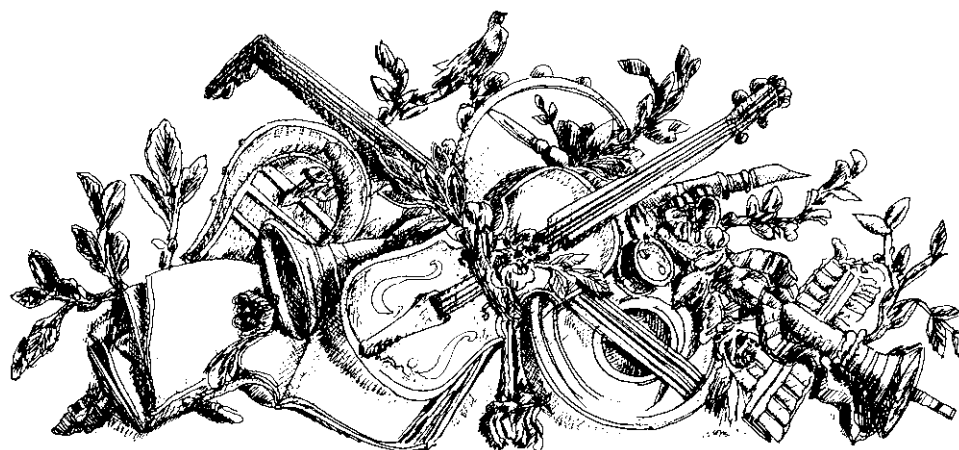

B 120 cm · H 50 cm · T 10 cm

SUP 2093

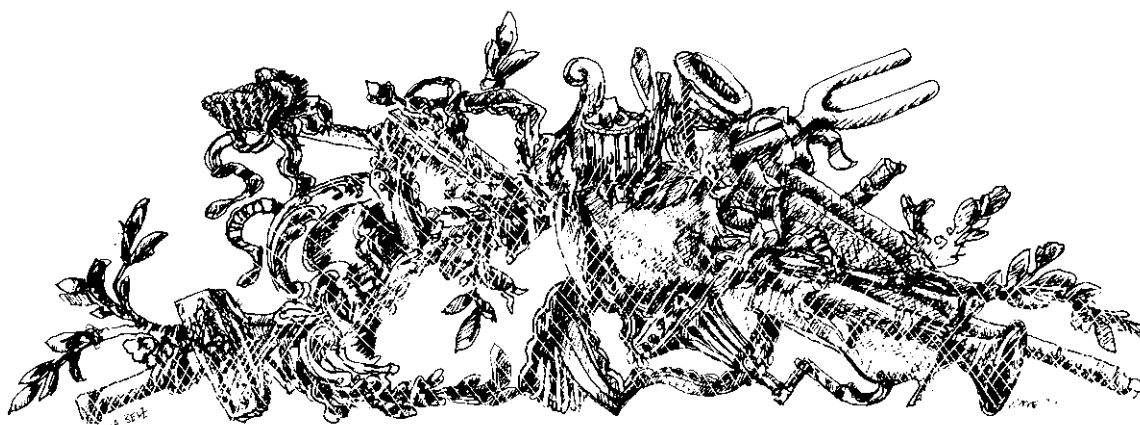

B 124 cm · H 43 cm · T 8 cm

SUP 2094

Säulen • Pilaster

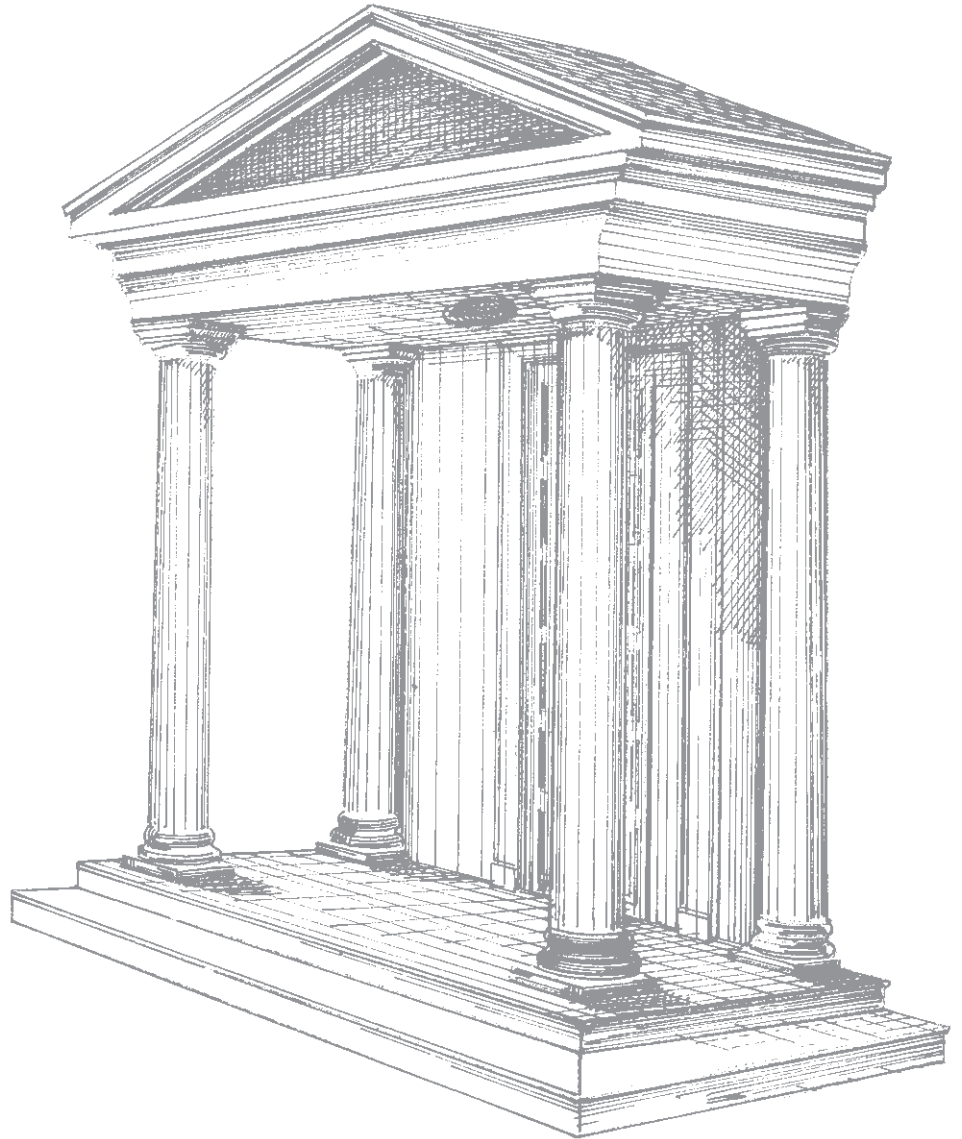

Die Verwendungsmöglichkeiten von Säulen im Innen- und Außenbereich sind vielfältig.

Ob sie als Sockel für Glastische oder als optische Stützen für Vordächer oder Unterzüge dienen – sie sind auf jeden Fall ein Blickfang in der gewohnten Umgebung.

Flache Pfeilervorlagen bezeichnet man als Pilaster. Auch ihre Verwendung kann jeweils auf Ihre Ansprüche angepaßt werden. Wir beraten Sie gerne.

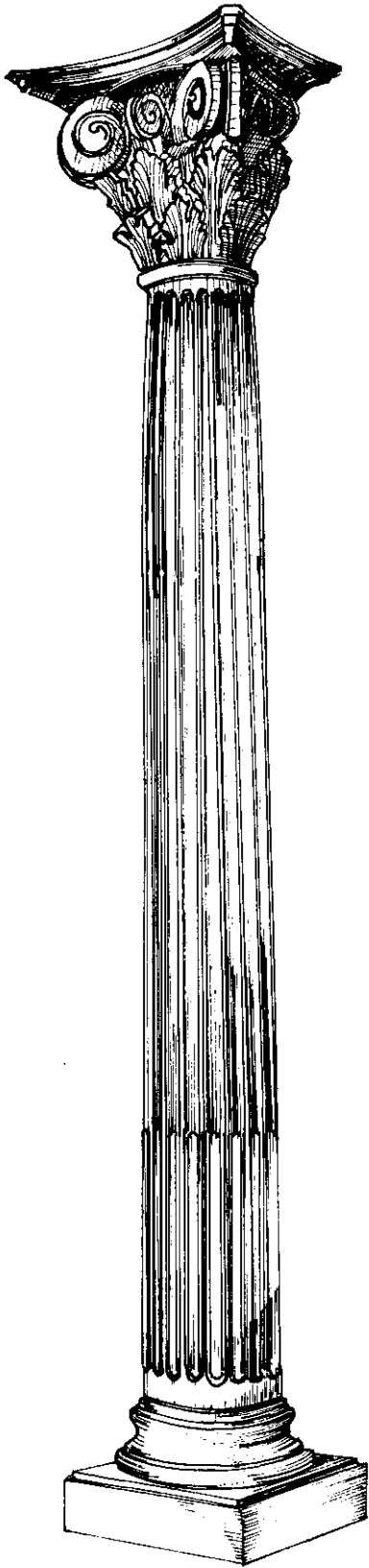

H 275 bis 305 cm
Schaft Ø 21 bis 27 cm

SÄU 2530

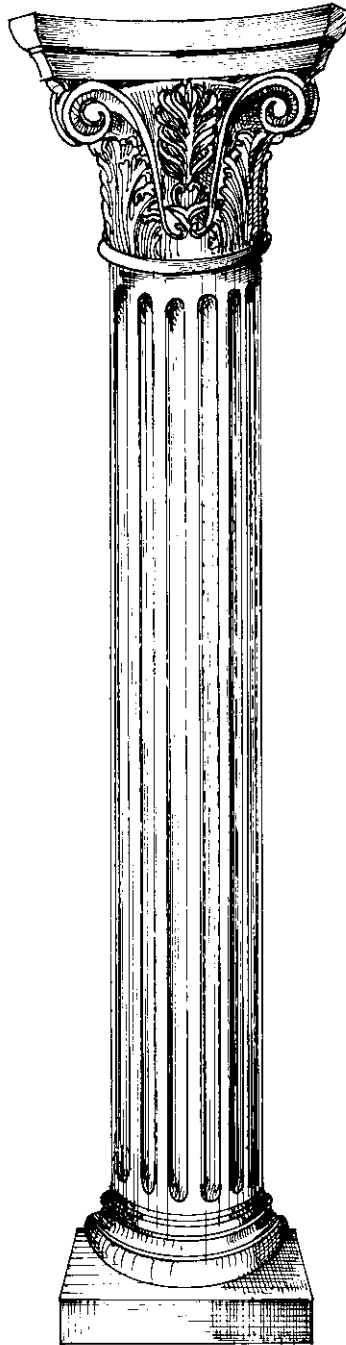

Maße auf Anfrage

SÄU 2531

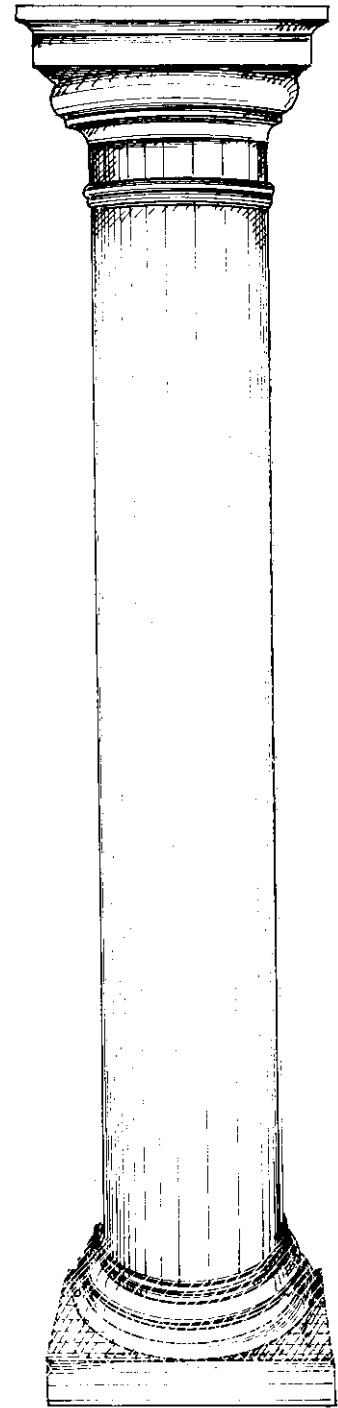

Maße auf Anfrage

SÄU 2532

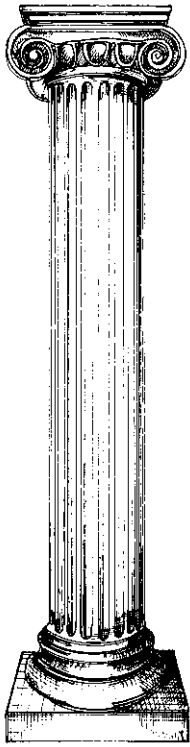

Maße auf Anfrage

SÄU 2533

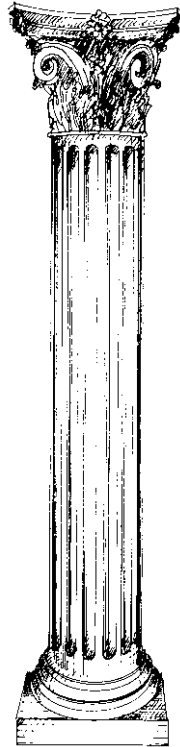

Maße auf Anfrage

SÄU 2534

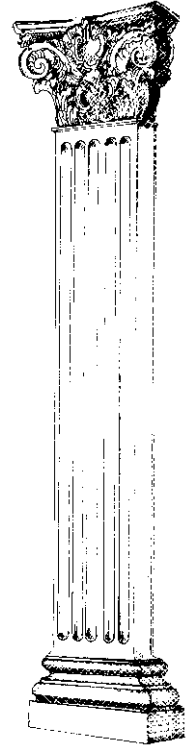

Maße auf Anfrage

PIL 2535

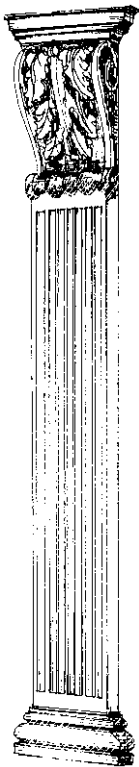

Maße auf Anfrage

PIL 2536

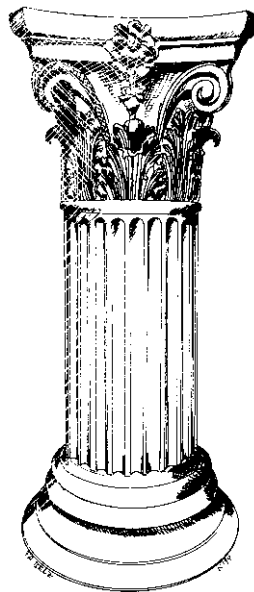

H 85 cm
Platte 36 cm x 36 cm

SÄU 2537

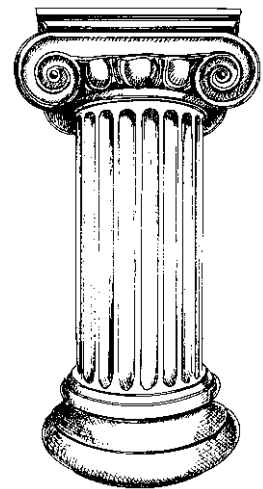

H 75 cm
Platte 35 cm x 33 cm

SÄU 2538

Kapitelle - Konsolen

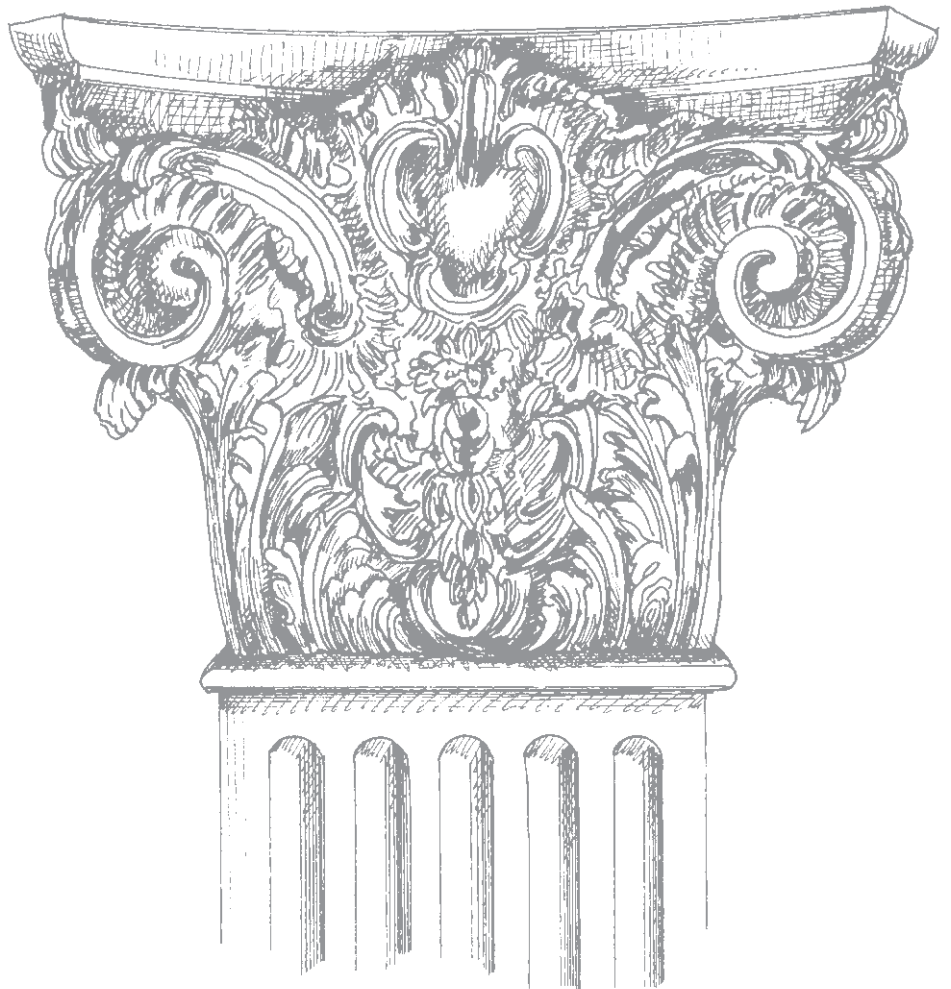

Kapitelle bilden entweder als Einheit oder in Kombination mit unseren Säulen und Pilastern das schmückende Kopfstück.

Das Wort „Konsole“ stammt aus dem Französischen und bedeutet soviel wie „Vorsprung an einer Wand“.

Wir zeigen Ihnen eine Vielzahl unterschiedlicher Formen und Motive als tragende Elemente für Unterzüge, Gewölbe und Figuren.

KAPITELLE · KONSOLEN

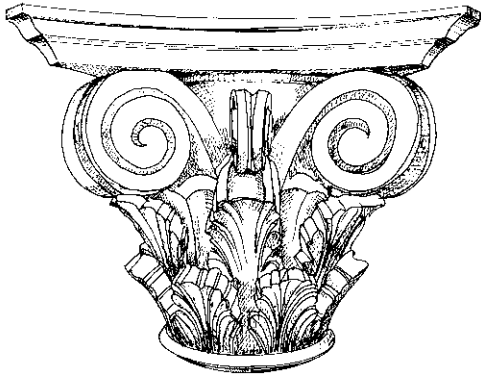

B 56 cm · H 40,5 cm · T 28 cm

KAP 523



Bo 37 cm · Bu 21 cm · H 21 cm · T 18,5 cm

KAP 515



Bo 37 cm · Bu 21 cm · H 21 cm · T 18,5 cm

KAP 515 A

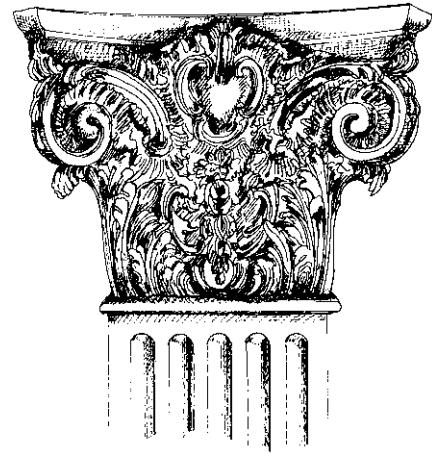

Bo 48 cm · Bu 31 cm · H 37 cm · T 17 cm

KAP 3000

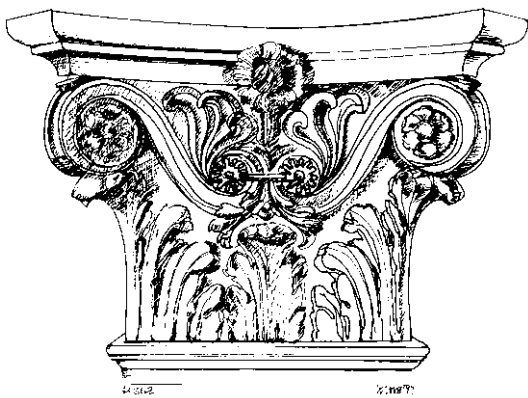

Bo 72 cm · Bu 43 cm · H 50 cm · D 18 cm

KAP 3001

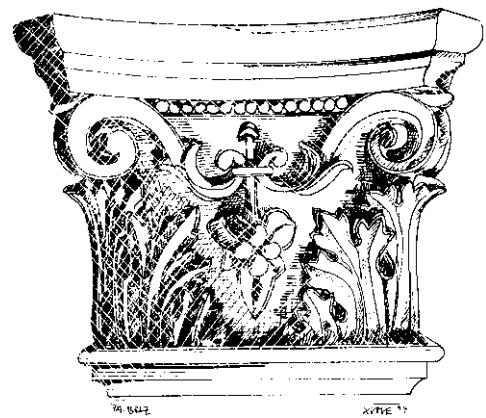

Bo 24,5 cm · Bu 16 cm · H 20 cm · D 7 cm

KAP 529

KAPITELLE · KONSOLEN

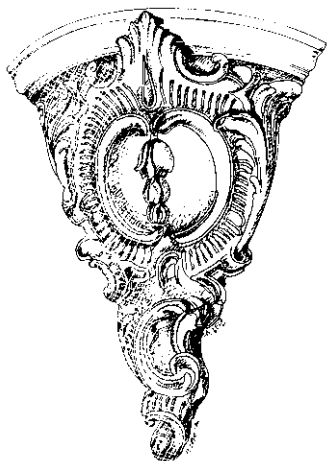

B 30 cm · L 30 cm · H 60 cm

KON 3002

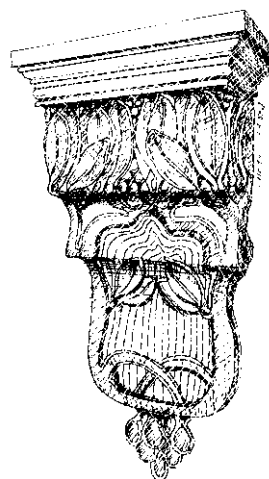

B 27 cm · H 48 cm · D 11 cm

KON 3003

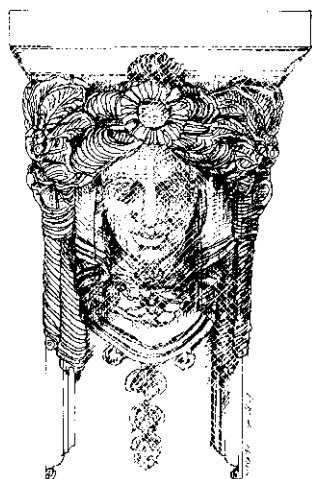

B 30,5 cm · H 54 cm · D 13 cm

KON 502

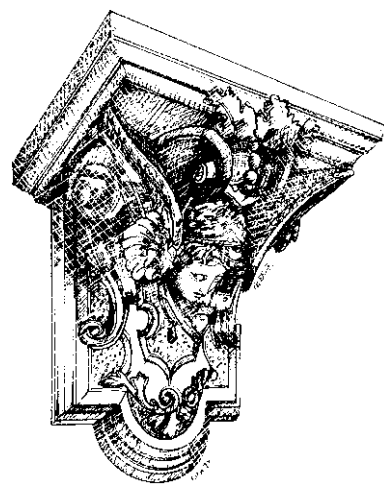

B 42 cm · H 47 cm · T 35 cm

KON 3004



B 30 cm · H 34 cm · D 9 cm

KON 3005

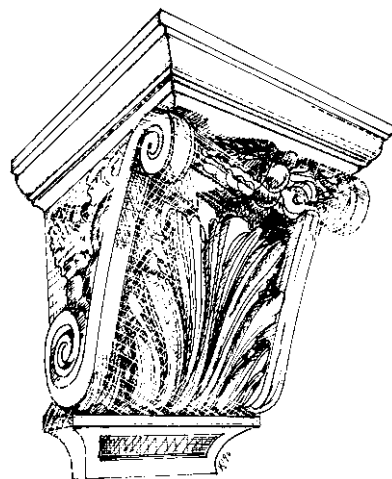

B 31 cm · H 35 cm · T 28 cm

KON 3006



B 19 cm · H 43 cm
T 14 cm

KON 596

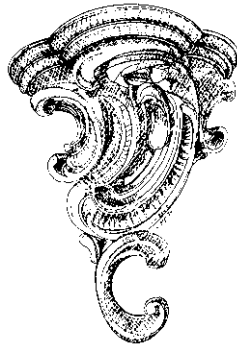

B 24 cm · H 29 cm
T 19 cm

KON 522

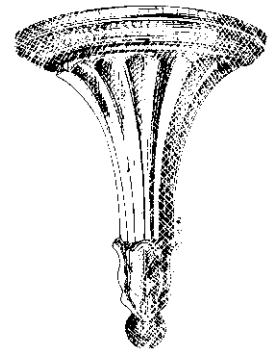

B 26 cm · H 29 cm
T 12,5 cm

KON 520

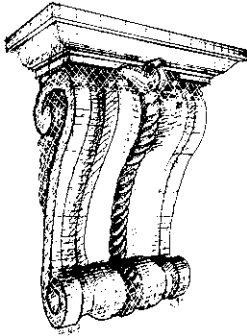

B 21,5 cm · H 26 cm
T 10 cm

KON 516

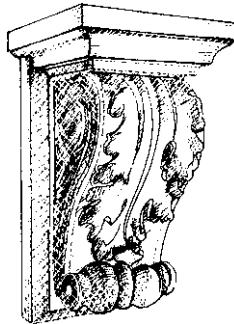

B 10,5 cm · H 17 cm
T 9 cm

KON 264

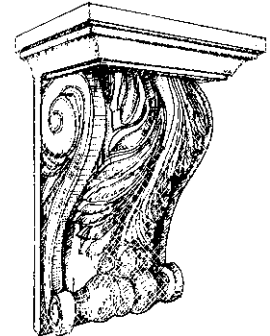

B 23 cm · H 30 cm
T 11 cm

KON 504

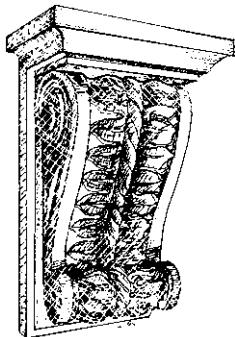

B 14 cm · H 21 cm
T 8 cm

KON 248

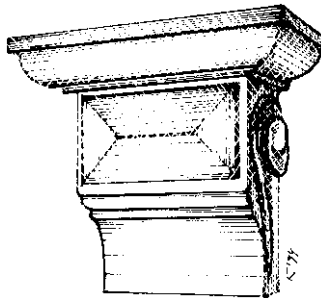

B 24,5 cm · H 22 cm
T 13,5 cm

KON 3007

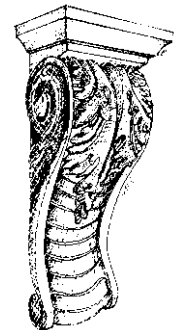

B 13 cm · H 30,5 cm
T 9 cm

KON 219



B 13 cm · H 54 cm
T 12 cm

KON 3008

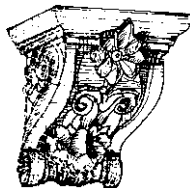

B 10 cm · H 12,5 cm
T 11 cm

KON 3009

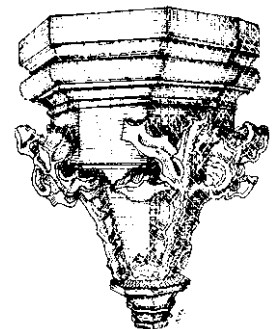

B 24,5 cm · H 30 cm
T 26 cm

KON 3010

Lichtverteiler

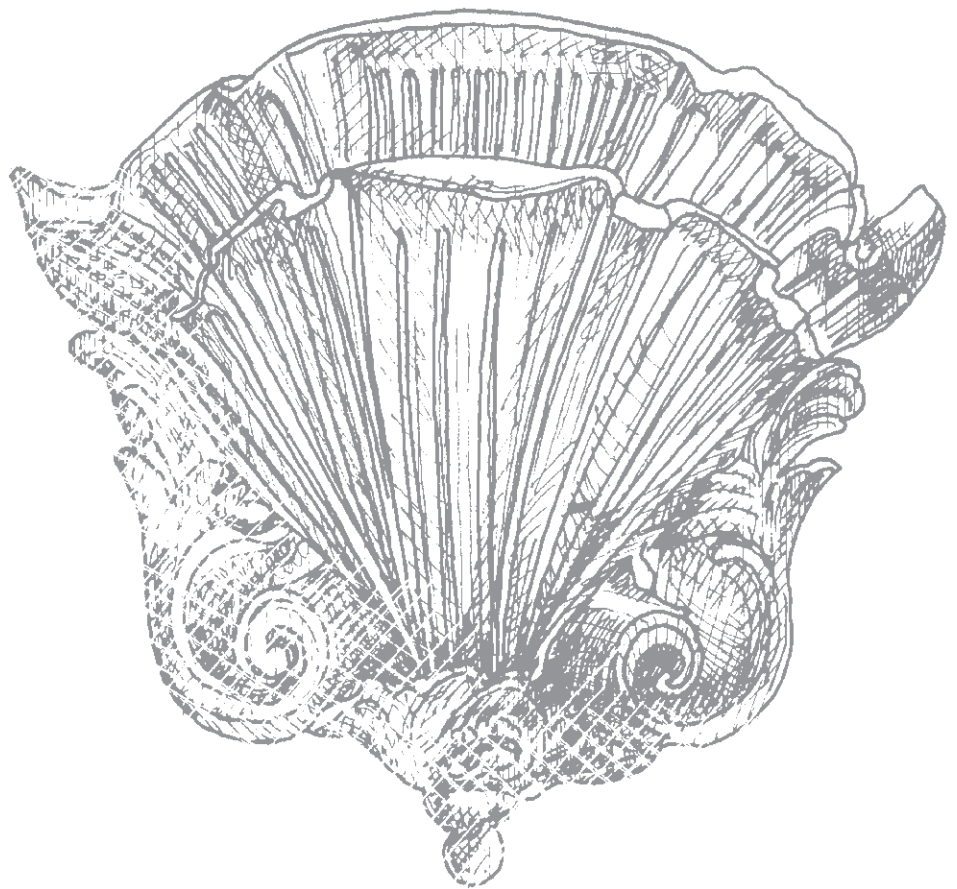

Verzaubern Sie Ihre Räumlichkeiten durch den Einsatz von Lichtverteilern. Gezielt angebracht verleihen sie durch die indirekte Beleuchtung ihrer Umgebung eine Atmosphäre behaglicher Eleganz.

Überzeugen Sie sich von der Wirkung dieser Dekorelemente in unseren Ausstellungsräumen in Bonn.

LICHTVERTEILER

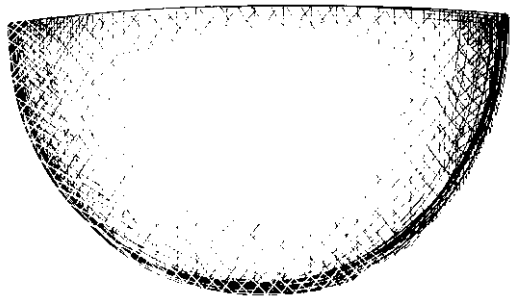

B 35,5 cm · H 17 cm · T 14 cm

LI 1001

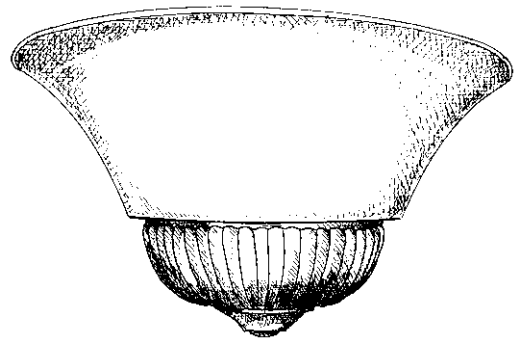

B 42 cm · H 22 cm · T 18 cm

LI 1004

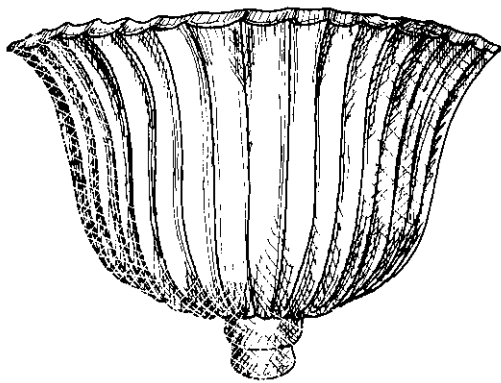

B 32,5 cm · H 24,5 cm · T 14 cm

LI 080

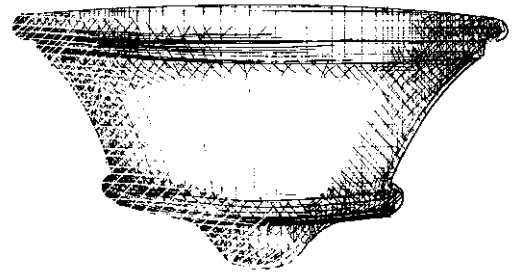

B 31 cm · H 15 cm · T 15,5 cm

LI 081

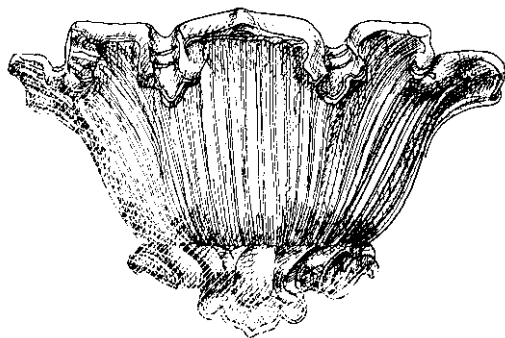

B 35 cm · H 21 cm · T 12 cm

LI 416

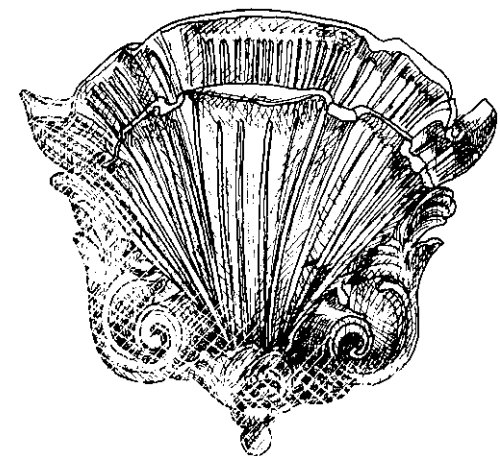

B 31 cm · H 27,5 cm · T 11 cm

LI 19

Dekorelemente



U nser reichhaltiges Sortiment an Dekorelementen bietet Ihnen viele Möglichkeiten einer freien Gestaltung Ihrer Wohnumgebung. Plastische Bilder und Büsten gehören ebenso zu unserem Angebot wie auch der Service, nach Ihren Wünschen oder Vorlagen individuelle Unikate für Sie anzufertigen.



B 66 cm · H 81 cm · D 8 cm

DEK 549



B 66 cm · H 81 cm · D 8 cm

DEK 550



H 44 cm

DEK 5001



B 69 cm · H 59 cm

DEK 541



B 88 cm · H 41 cm

DEK 5002



H 25,5 cm

DEK 5003

DEKORELEMENTE

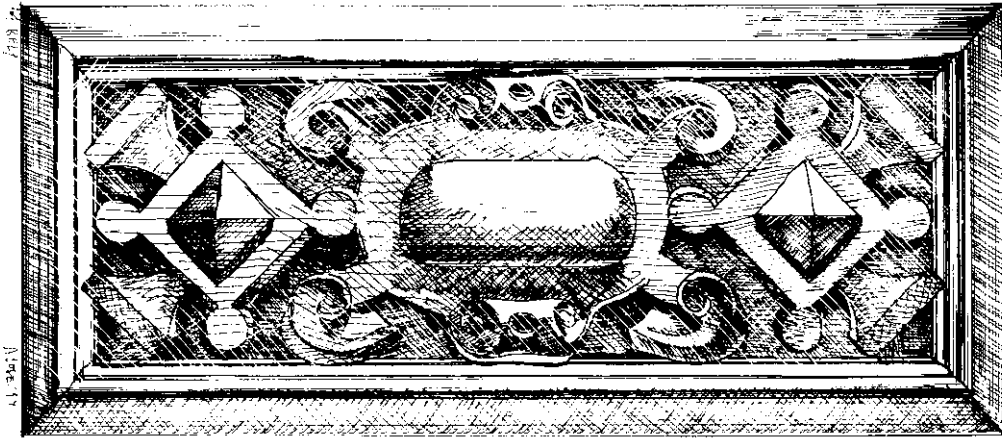

B 90 cm · H 39 cm

DEK 5004

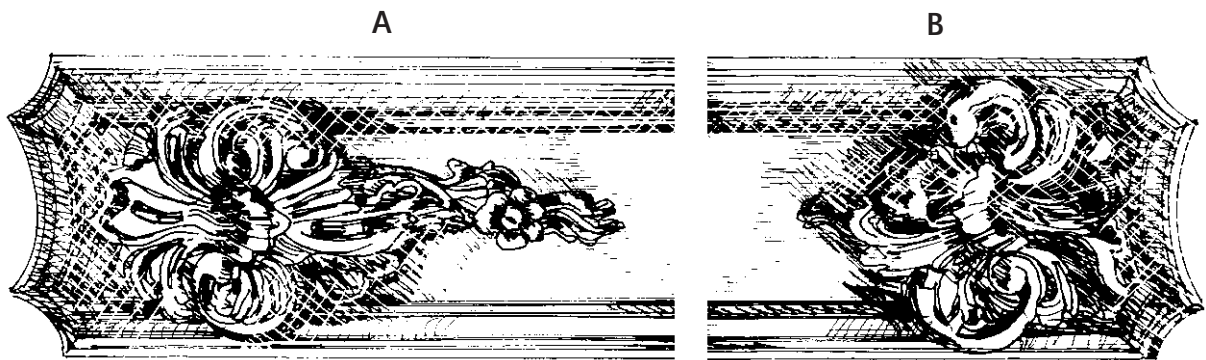

DEK 5005 A

DEK 5005 B

A) B 13 cm · L 27 cm / B) B 13 cm · L 18 cm

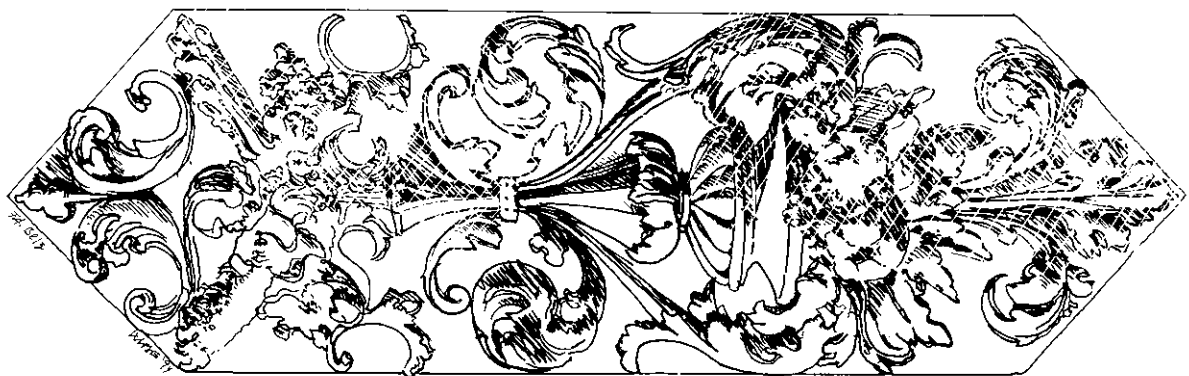

B 31 cm · L 101 cm

DEK 5006

DEKORELEMENTE

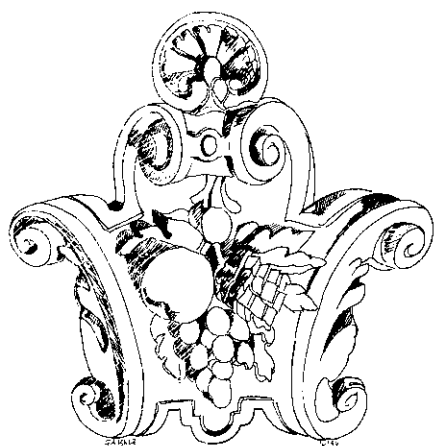

B 40 cm · H 38 cm

DEK 5007

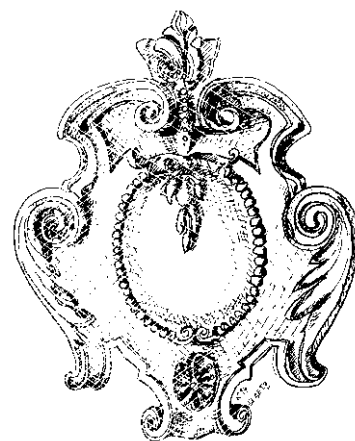

B 34 cm · H 42 cm

DEK 5008

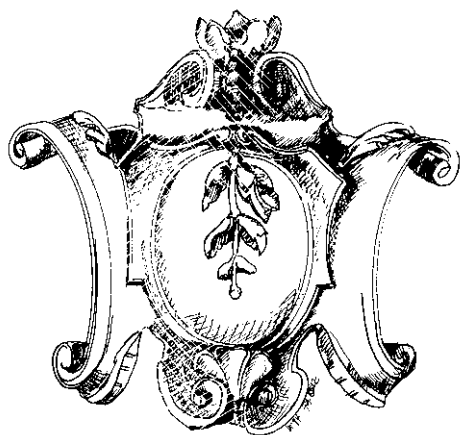

B 34 cm · H 32 cm

DEK 5009

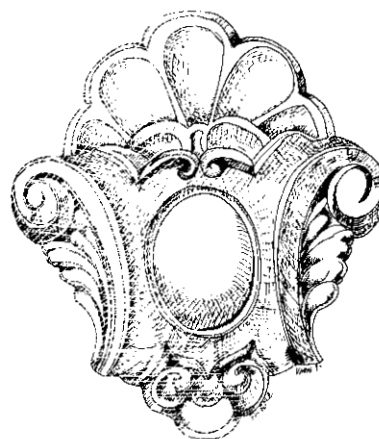

B 27 cm · H 31 cm

DEK 5010



B 41 cm · H 37 cm

DEK 5011

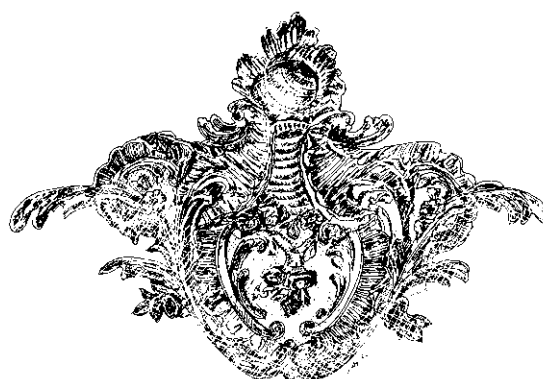

B 66 cm · H 45 cm

DEK 5012

DEKORELEMENTE

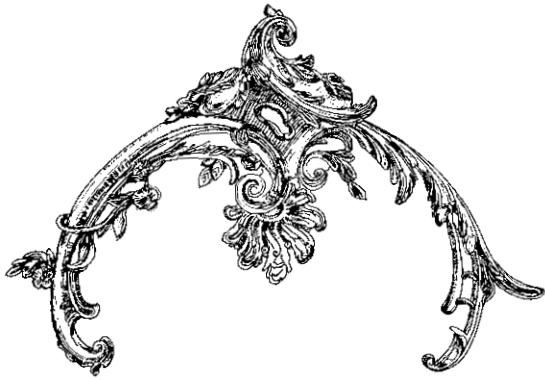

B 70 cm · H 46 cm

DEK 607

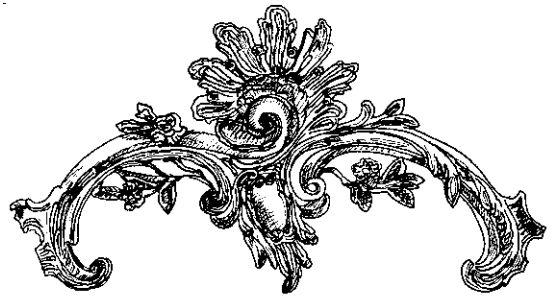

B 49 cm · H 28 cm

DEK 610



❶ (DEK 611) L 45 cm
❷ (DEK 609) L 43 cm

DEK 611

DEK 609

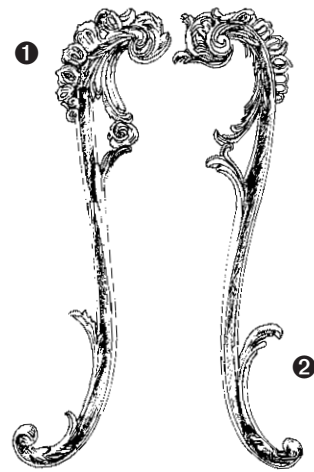

❶ (DEK 603 S) L 65 cm
❷ (DEK 603 D) L 65 cm

DEK 603 S

DEK 603 D

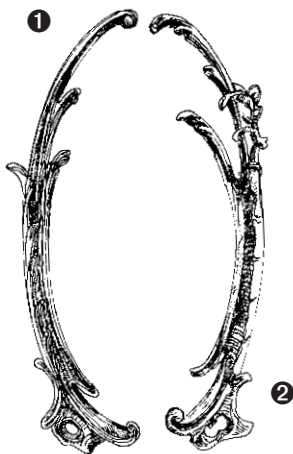

❶ (DEK 608) L 54 cm
❷ (DEK 612) L 54 cm

DEK 608

DEK 612

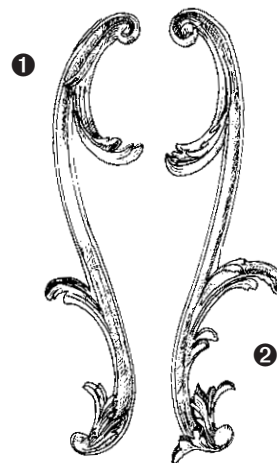

❶ (DEK 602 S) L 53 cm
❷ (DEK 602 D) L 53 cm

DEK 602 S

DEK 602 D

DEKORELEMENTE

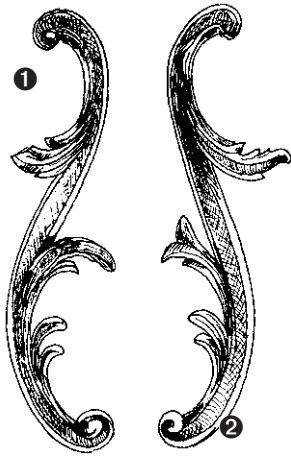

- ❶ (DEK 601 S) L 40 cm
- ❷ (DEK 601 D) L 40 cm

DEK 601 S

DEK 601 D



B 77 cm · H 50 cm

DEK 600



B 27 cm

DEK 604

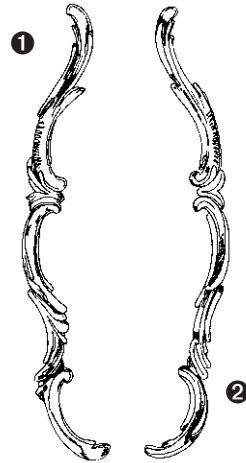

- ❶ (DEK 605 S) L 64 cm
- ❷ (DEK 605 D) L 64 cm

DEK 605 S

DEK 605 D



B 68 cm · H 17 cm

DEK 613



B 40 cm · H 33 cm

DEK 614

KAMINNE • KONSCHEN

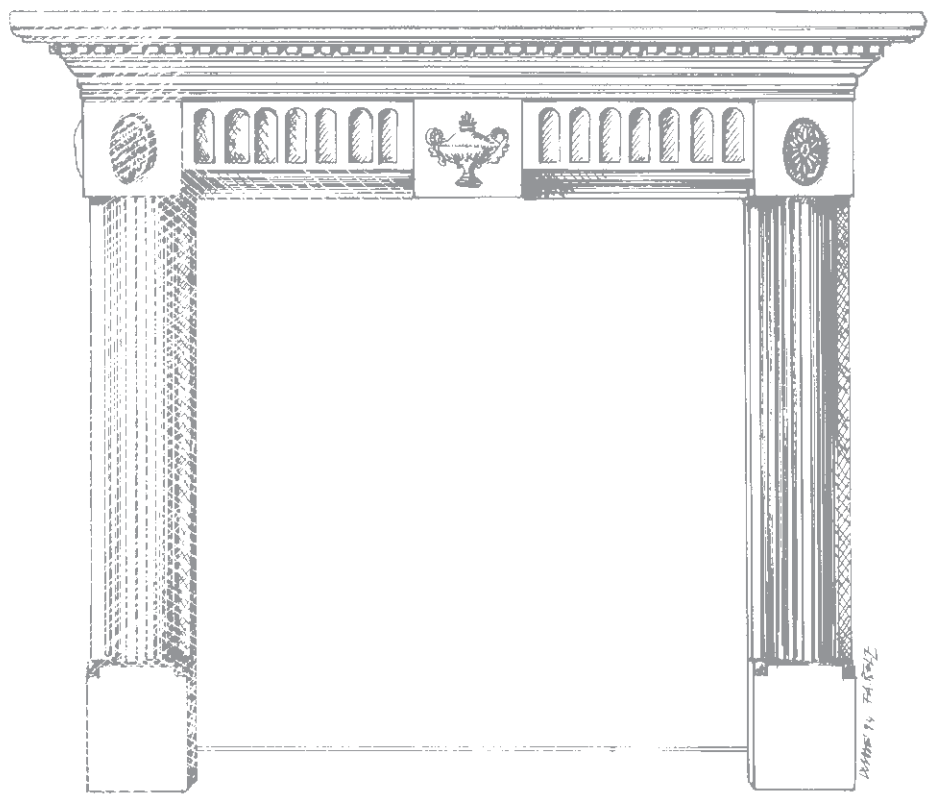

Unsere hochwertigen klassischen Kaminverkleidungen werden in der Regel um vorhandene Feuerungsöffnungen gesetzt, wirken jedoch ebenso elegant als einfache dekorative Wandverkleidung.

Als weiterer Blickpunkt in Ihrer Wohnumgebung dienen unsere Konschen. Sie sind in vielen Ausführungen erhältlich und werden als Fertigteile in vorbereitete Wandöffnungen oder Raumecken eingesetzt.

Die Möglichkeit einer Innenbeleuchtung ist bei einigen Konschen bereits vorgesehen.

KAMINE · KONSCHEN

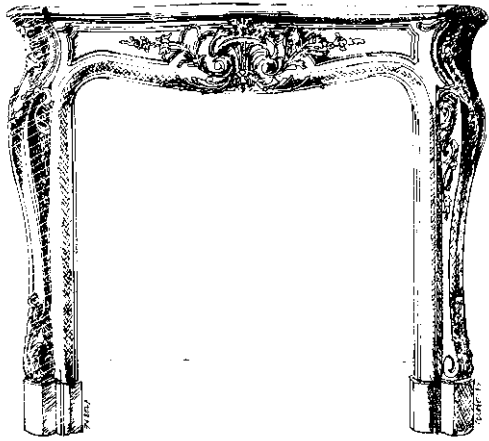

KAM 651 C

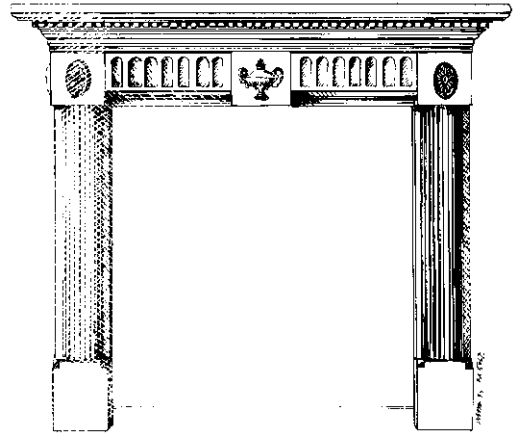

KAM 652 C

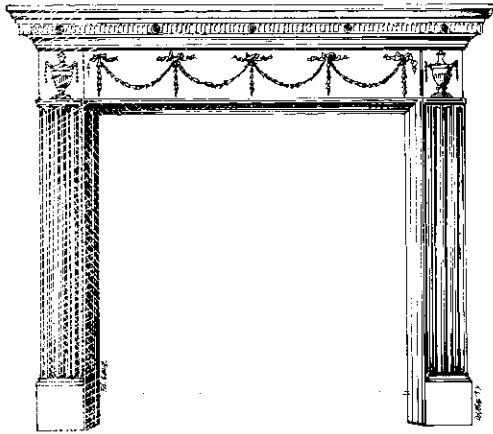

KAM 653 C

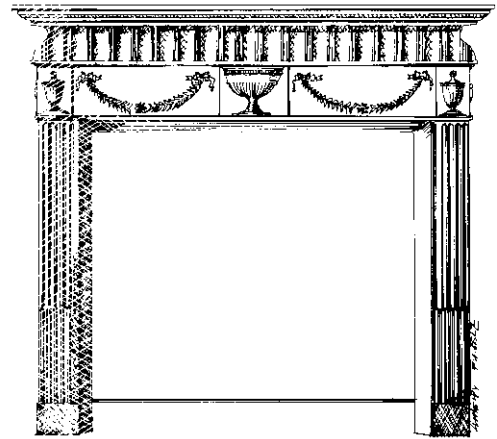

KAM 654 C

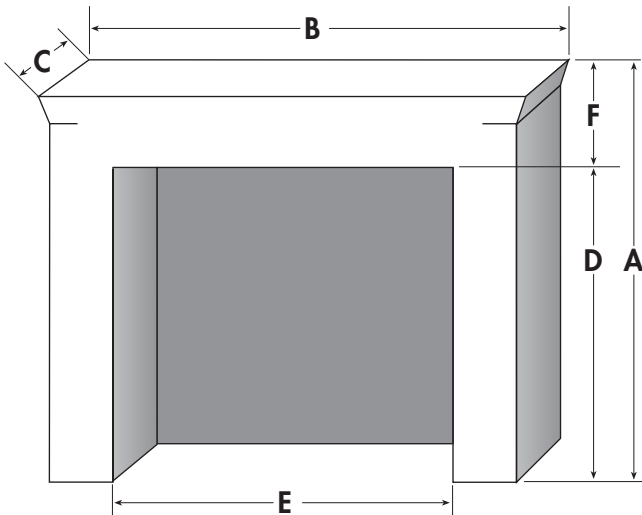

	KAM 651 C	KAM 652 C	KAM 653 C	KAM 654 C
A	122,5	115,5	115,0	118,0
B	136,0	134,0	134,0	134,5
C	24,0	20,5	15,5	15,5
D	103,0	89,0	86,5	83,5
E	98,5	87,0	86,0	92,0
F	24,0	26,0	29,0	35,5

(Alle Maßeinheiten in cm)

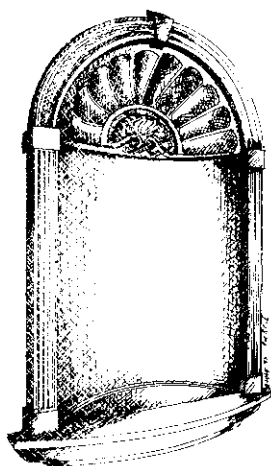

B 78 cm · H 122 cm · T 28 cm

KON 5501

Eckkonsche

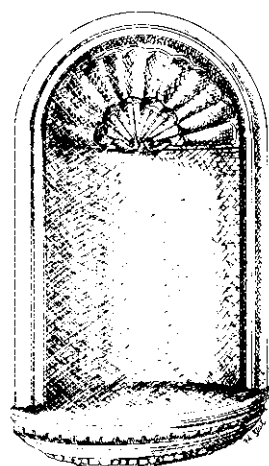

B 50 cm · H 65 cm · T 34 cm

KON 547

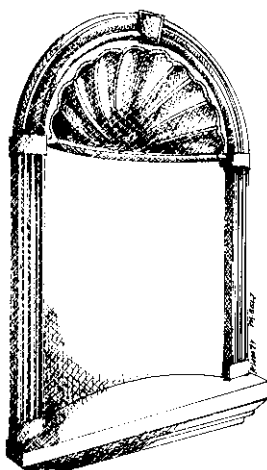

B 65 cm · H 96 cm · T 24 cm

KON 546



B 37 cm · H 67 cm (o. Muschel) · T 30 cm

KON 242

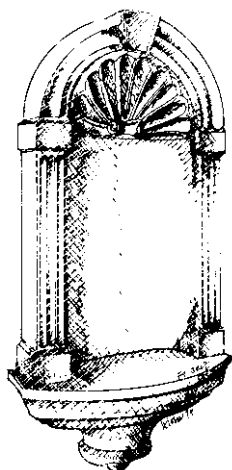

B 28 cm · H 56 cm · D 10 cm

KON 562

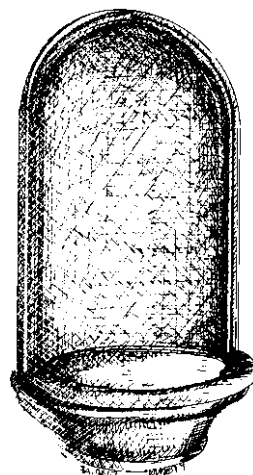

B 31 cm · H 62 cm · T 30 cm

KON 5502

BALUSTIER

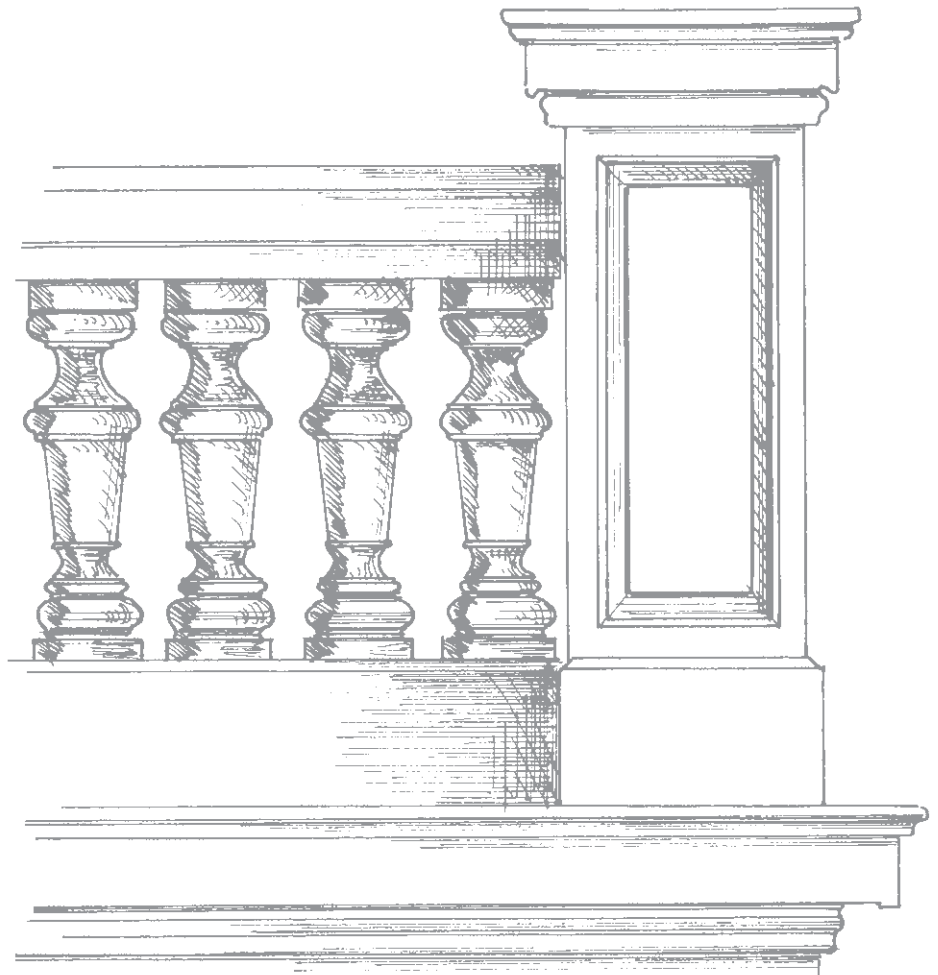

Balustraden sind sowohl für den Innen-, als auch für den Außenbereich einsetzbar. Angepaßt an die jeweiligen Raum- und Platzverhältnisse kommen entweder unsere preiswerten Fertigteile oder individuell gefertigte Balustraden zum Einsatz.

Darüber hinaus bieten wir Ihnen auch gebogene oder geschwungene Formen an, was das Einsatzspektrum noch wesentlich erweitert.

BALUSTER

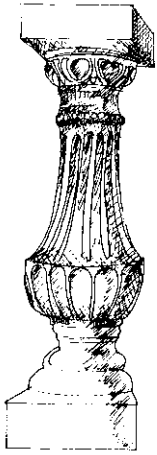

B 15 cm · H 52 cm

BAL 6001

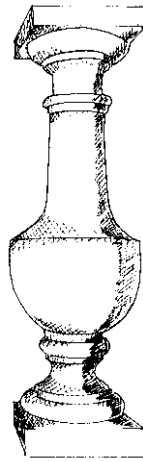

B 16 cm · H 60 cm

BAL 6002

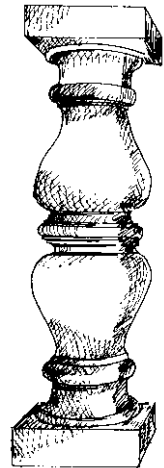

B 14 cm · H 50 cm

BAL 6003

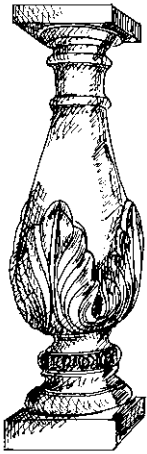

B 13 cm · H 47 cm

BAL 6004

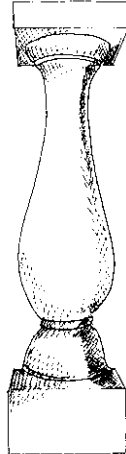

B 15 cm · H 60 cm

BAL 6005

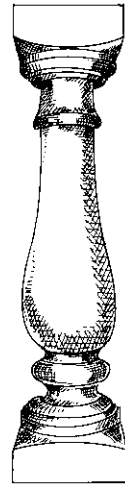

B 16 cm · H 65 cm

BAL 6280

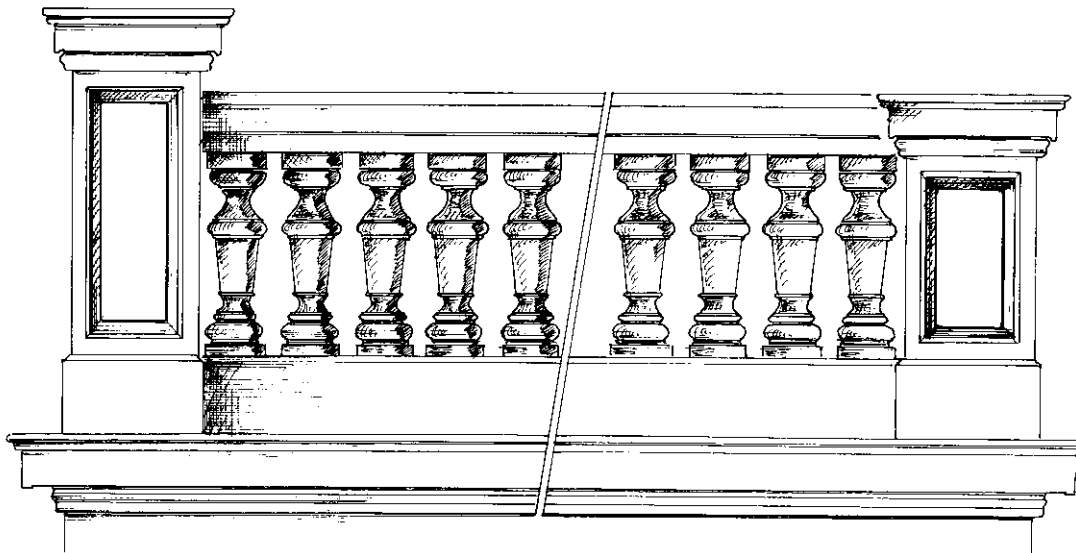

Der Weg zu uns

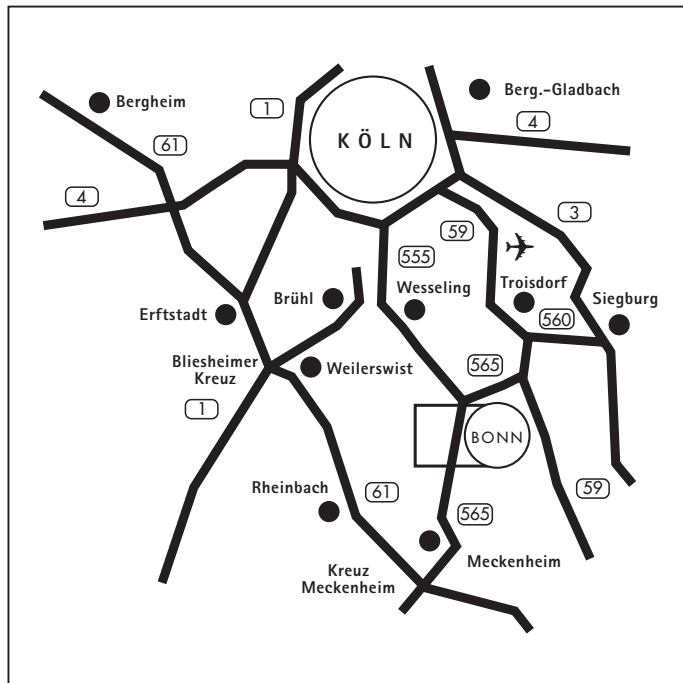
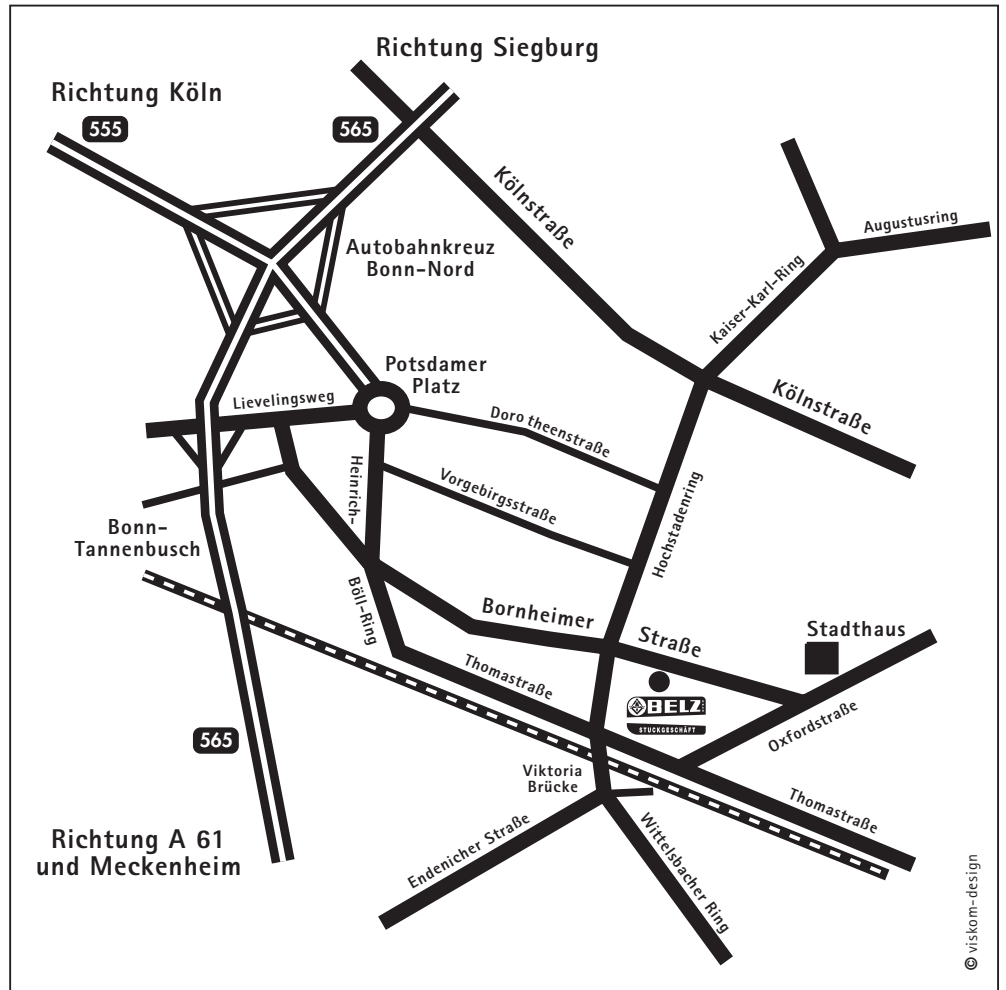

BELZ GMBH · BORNHEIMER STRASSE 33a · 53111 BONN

TELEFON (0228) 60 40 7-0 · FAX (0228) 60 40 777

eMail: stuck@belz.de · www.belz.de

Illustrationen: Atelier Ralf Klose, Bonn

BELZ GMBH · STUCK - PUTZ - TROCKENBAU

BORNHEIMER STRASSE 33a · 53111 BONN

TELEFON (0228) 60 40 7-0 · FAX (0228) 60 40 777

eMail: stuck@belz.de · www.belz.de

